



YJ-NR-3030HP-G02

Surface Mount Device



Applications

- Horticulture lighting

Features

- Full-spectrum for the coverage of Photosynthetically Active Radiation (PAR)
- Photosynthetic photon flux (PPF) 0.53 $\mu\text{mol/s}$
- Photosynthetic efficacy 3.0 $\mu\text{mol/J}$
- 3.0mm \times 3.0mm universal package
- Lifespan > 54000 hours (IES LM80)
- SimpleBinning solution

[About Yujileds[®]](#)

Document Number: YJWJ134

Rev Version: 2.1

P3200019.00

Table of Contents

General description	3
Ordering information	4
Characteristics	5
Electrical-optical characteristics.....	5
Absolute maximum ratings	6
Chromaticity group and diagram	7
Chromaticity bins & coordinates	7
CIE 1931 diagram.....	7
Reliability	8
Package material and dimension.....	9
Package layout.....	9
Package materials.....	9
Characteristic graph	10
Typical spectral power distribution	10
Forward current.....	11
- Vs. forward voltage	11
- Vs. relative luminous flux	11
- Vs. relative chromaticity shift.....	12
- Vs. absolute chromaticity shift.....	12
- Derating based on solder point	12
Solder point temperature.....	13
- Vs. forward voltage	13
- Vs. relative luminous flux	13
- Vs. relative chromaticity shift.....	13
- Vs. absolute chromaticity shift.....	14
Spatial distribution	15
Solder and reflow profile	16
Recommended solder pad layout.....	16
Reflow profile.....	16
SMT instruction	17

Problems caused by improper selection of collet.....	17
Collet selection.....	17
Other notes of caution.....	17
Tape and reel specifications	18
Box packaging	20
About Yujileds	21

General description

Yujileds® Nourish series 3030 LED is designed for high photosynthetic efficacy performance in horticulture lighting. Manufactured with the blue (typical 450nm) die, mixing with Yuji advanced phosphors for specifically designed spectral recipes. It is one of the most economical solutions of low-power LED but provides industrial highest photosynthetic efficacy.

The Nourish series 3030 LED also supports the unique service/certification by Yujileds® as described below.



IESNA LM-80-08 certification

9000 hours data (300mA) of chromaticity shift and TM-21 reported L70 lifetime at 55°C, 85°C and 105°C.

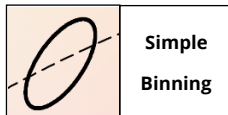

SimpleBinning specification

Simplify the chromaticity binning with TrueChroma data support to provide the most economical, simple, and practical solution to customers.



RoHS 2011/65/EU compliance



CE compliance



REACH compliance (Phosphor)

Ordering information

PART NUMBER	PRODUCT CODE	CCT	CHROMATICITY BINS	VOLTAGE RANGE
YJ-NR-3030HP-G02-30	P3200019.30	3000K	H30	0.1V
YJ-NR-3030HP-G02-40	P3200019.40	4000K	H40	0.1V
YJ-NR-3030HP-G02-50	P3200019.50	5000K	H50	0.1V
YJ-NR-3030HP-G02-XX	P3200019.XX	Custom CCT	-	0.1V

Characteristics

Electrical-optical characteristics ($T_A = 25^\circ\text{C}$, 65mA)

PARAMETER	SYMBOL	VALUE			UNIT	TOLERANCE
		MIN.	TYP.	MAX.		
Forward voltage	V_F	2.6	-	2.8	V	± 0.05
Luminous flux	Φ_{3000K}	36	-	38	lm	-
	Φ_{4000K}	38	-	40		
	Φ_{5000K}	38	-	40		
Correlated color temperature¹	CCT_{3000K}	-	3000	-	K	-
	CCT_{4000K}	-	4000	-		
	CCT_{5000K}	-	5000	-		
Radiant flux	Φ_{e3000K}	105	-	115	mW	-
	Φ_{e4000K}	110	-	120		
	Φ_{e5000K}	110	-	120		
Photosynthetic photon flux	PPF_{3000K}	0.50	0.52	-	$\mu\text{mol/s}$	-
	PPF_{4000K}	0.51	0.53	-		
	PPF_{5000K}	0.52	0.54	-		
Photosynthetic Photon Efficacy	PPE_{3000K}	2.85	2.95	-	$\mu\text{mol/J}$	-
	PPE_{4000K}	2.90	3.00	-		
	PPE_{5000K}	2.95	3.05	-		
Color rendering index	R_a	-	80	-	-	± 1
Reverse current	I_r	-	-	10	μA	$\pm 0.1 (V_r = 5V)$
View angle	$2\theta_{1/2}$	-	120	-	Deg	± 5
Thermal resistance	$R_{\theta JS}$	-	15^2	-	$^\circ\text{C/W}$	-

1. Yujileds® promises the chromaticity coordinate tolerance of ± 0.0015 (CIE 1931 x,y) based on Yuji standard equipment shall prevail.
2. This data is for reference only.

Characteristics

Absolute maximum ratings ($T_A = 25^\circ\text{C}$)

PARAMETER	SYMBOL	LIMIT	UNIT
Power Consumption	P_D	1000	mW
DC Forward Current (pulsed)¹	I_{FP}	400 ²	mA
DC Forward Current	I_F	300	mA
Reverse Voltage	V_R	5	V
Junction Temperature	T_j	125	$^\circ\text{C}$
Solder Point Temperature³	T_s	105	$^\circ\text{C}$
Operating Temperature	T_{opr}	-40 ~ +85	$^\circ\text{C}$
Storage Temperature	T_{stg}	-30 ~ +100	$^\circ\text{C}$
Soldering Temperature	T_{sol}	260 \pm 5 (<10s)	$^\circ\text{C}$
Reflow Cycles Allowed	-	2	-

1. Pulse width $\leq 0.1\text{ms}$, duty $\leq 1/10$.
2. Theoretical data.
3. See page [Package material and dimension](#).

Chromaticity group and diagram

Chromaticity bins & coordinates

CCT	BIN	CIE 1931 COORDINATES							
		X0	Y0	X1	Y1	X2	Y2	X3	Y3
3000K	H30	0.4205	0.3986	0.4385	0.4156	0.4475	0.4071	0.4295	0.3902
4000K	H40	0.3693	0.3732	0.3873	0.3949	0.3947	0.3859	0.3767	0.3642
5000K	H50	0.3345	0.3485	0.3415	0.3415	0.3549	0.3621	0.3479	0.3691

CIE 1931 diagram

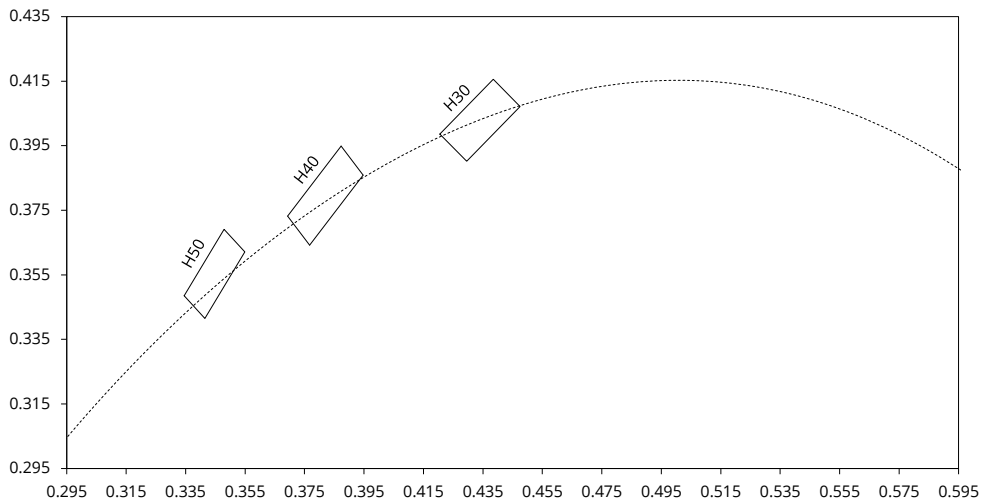

Reliability¹

$T_s = 55^\circ\text{C}$, $I_F = 300\text{mA}$, $\text{RH} < 65\%$, reported $L70 > 54000$ hours²

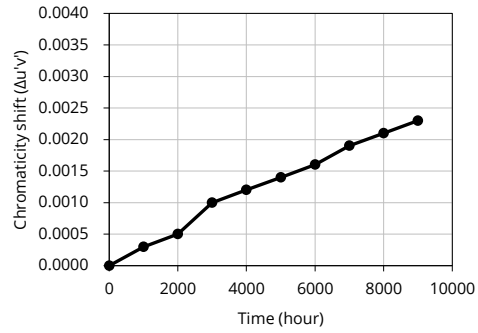
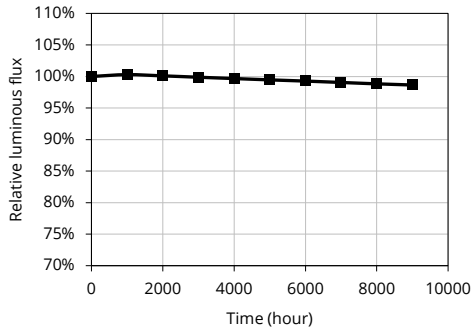

$T_s = 85^\circ\text{C}$, $I_F = 300\text{mA}$, $\text{RH} < 65\%$, reported $L70 > 54000$ hours

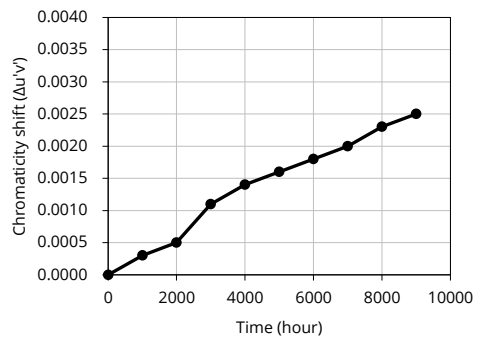
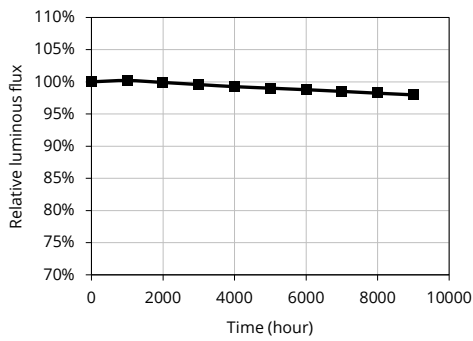

$T_s = 105^\circ\text{C}$, $I_F = 300\text{mA}$, $\text{RH} < 65\%$, reported $L70 > 54000$ hours

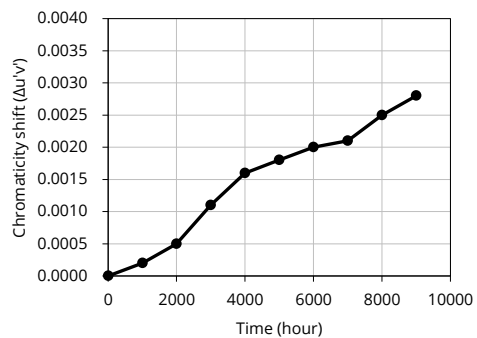
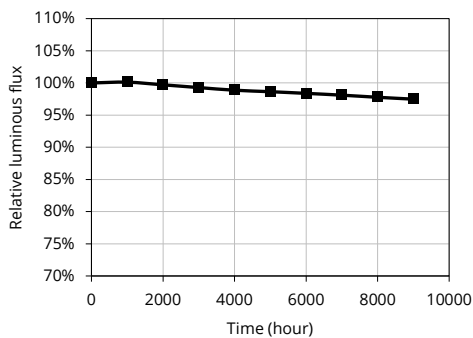

1. Data from IESNA LM-80-2008, report number R2DG160511050-10-M1.
2. Yujileds® reserves all the right for final explanation of reliability.

Package material and dimension

Package layout

All dimensions in mm, tolerance unless mentioned is ± 0.1 mm.

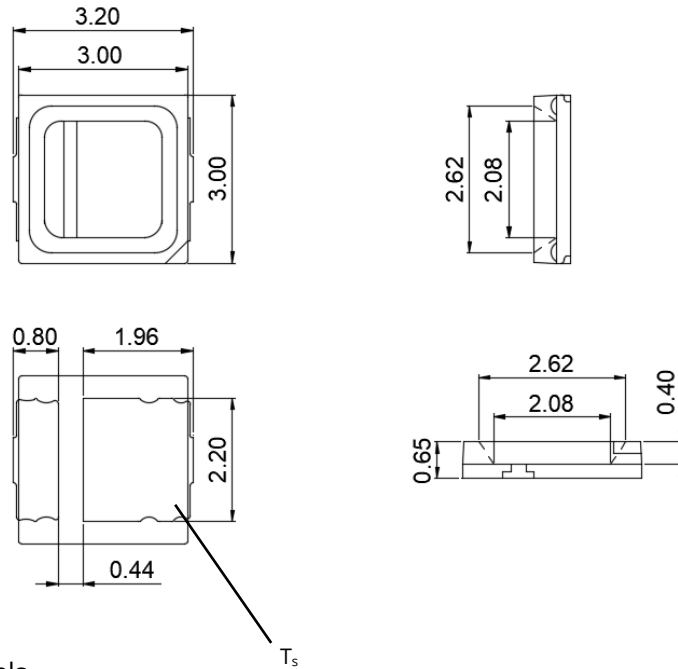

Package materials

ITEM	DESCRIPTION
Die material	InGaN
Lead frame material	PCT
Encapsulant resin material	Silicon + Phosphor
Electrodes material	Silver-plated copper

Characteristic graph

Typical spectral power distribution (normalized)

All characteristic curves are for reference only and not guaranteed.

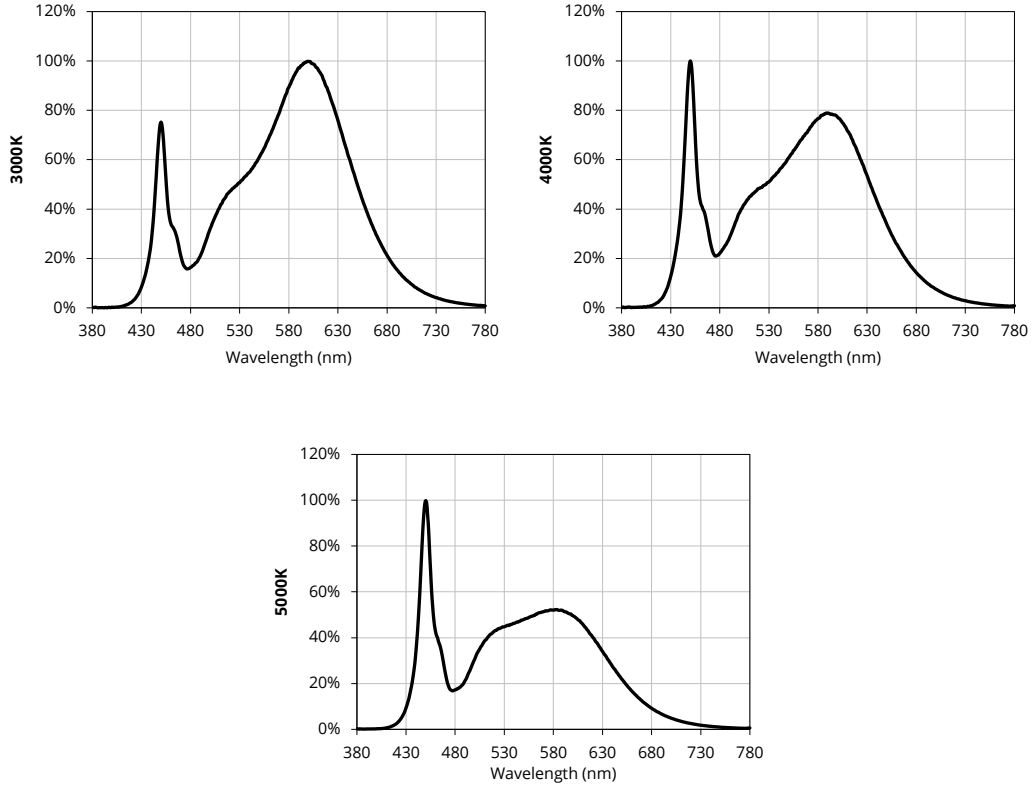

Characteristic graph

Forward current

All characteristic curves are for reference only and not guaranteed.

Vs. forward voltage

($T_A = 25^\circ\text{C}$)

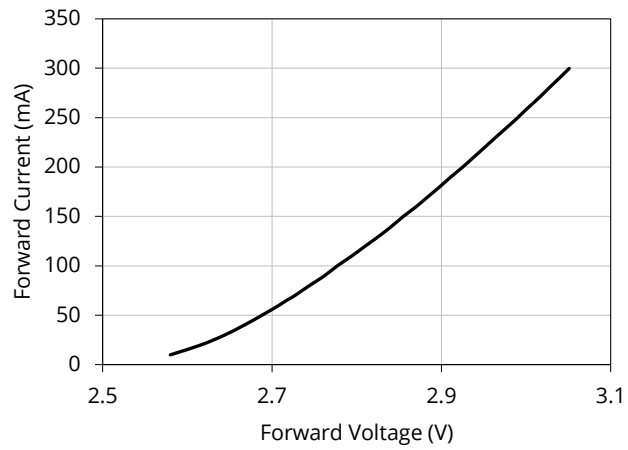

Vs. relative luminous flux

($T_A = 25^\circ\text{C}$)

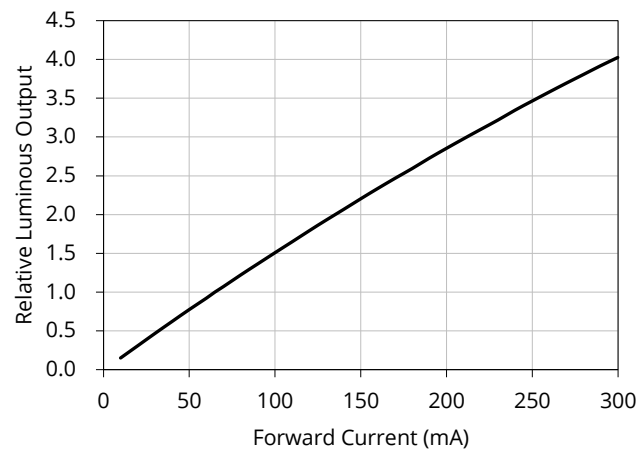

Characteristic graph

Forward current (continued)

All characteristic curves are for reference only and not guaranteed.

Vs. relative chromaticity shift

(4000K, $T_A = 25^\circ\text{C}$)

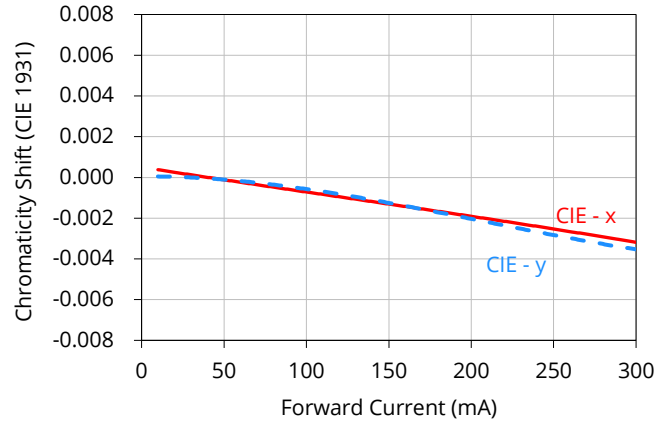

Vs. absolute chromaticity shift

(4000K, $T_A = 25^\circ\text{C}$)

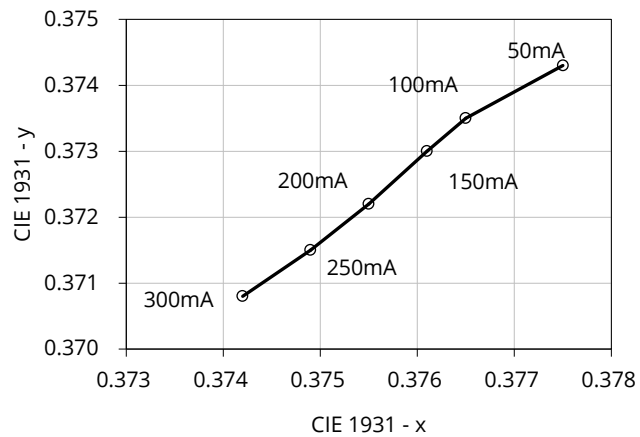

Derating based on solder point

Note: De-rating curves are meant for recommendation only and are not meant to provide guarantees of product stability and longevity.

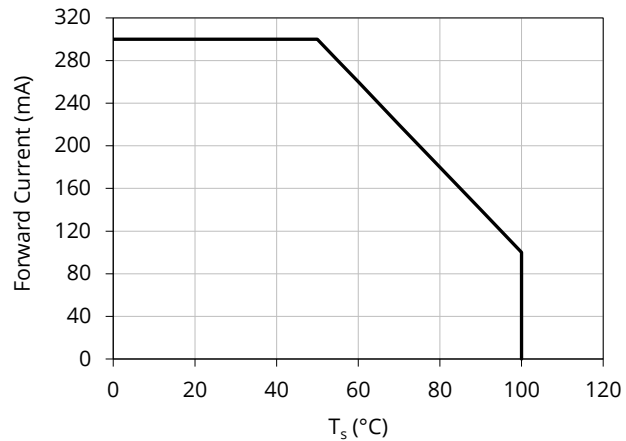

Characteristic graph

Solder point temperature (T_s)

All characteristic curves are for reference only and not guaranteed.

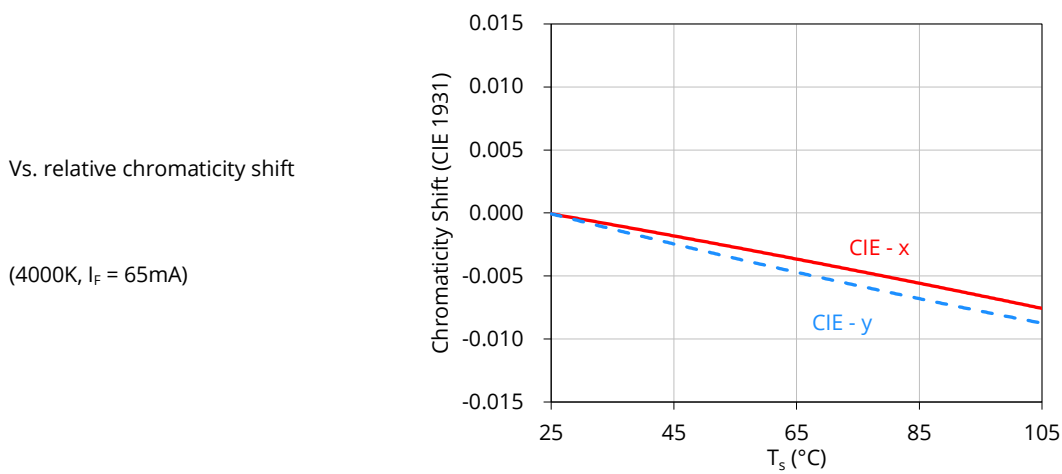
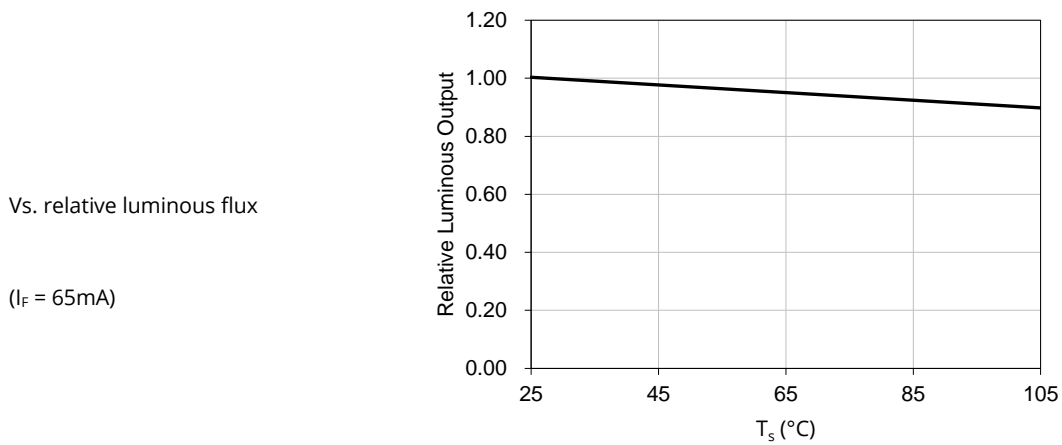
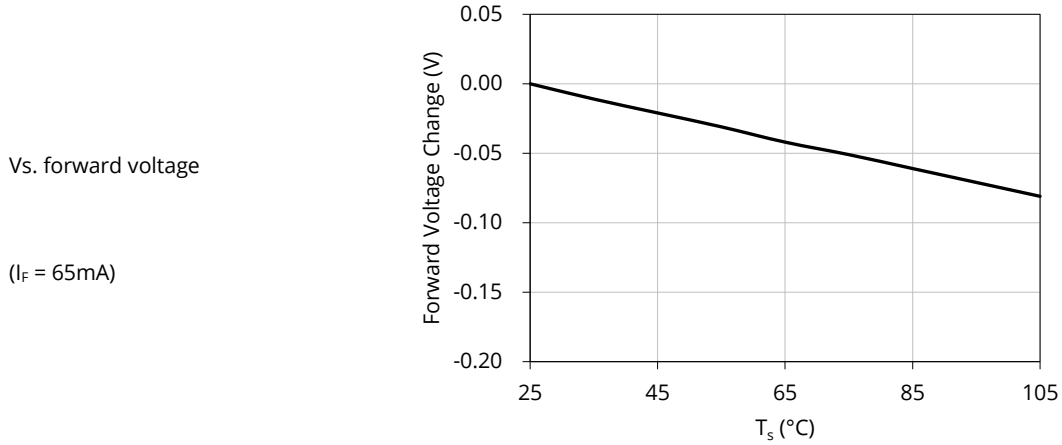

Characteristic graph

Solder point temperature (T_s) (continued)

All characteristic curves are for reference only and not guaranteed.

Vs. absolute chromaticity shift

(4000K, $I_F = 65\text{mA}$)

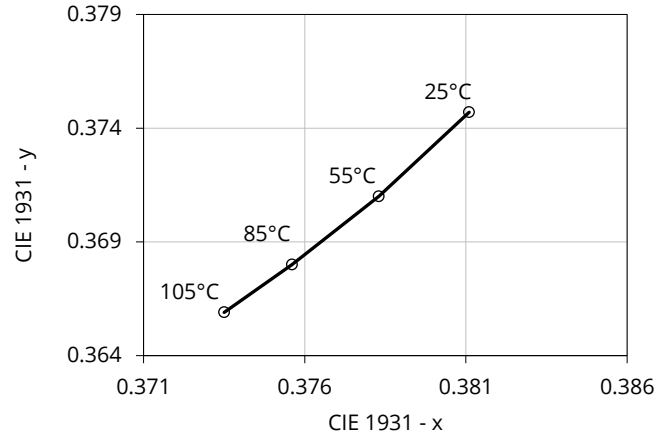

Characteristic graph

Spatial distribution ($T_A = 25^\circ\text{C}$, $I_F = 65\text{mA}$)

All characteristic curves are for reference only and not guaranteed.

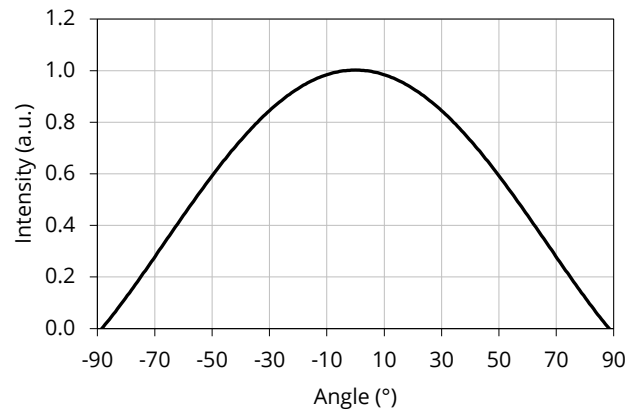

Solder and reflow profile

Recommended solder pad layout

All dimensions in mm, tolerance unless mentioned is ± 0.1 mm.

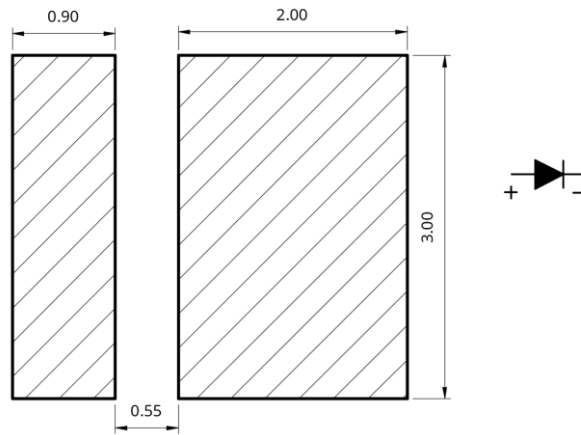

Reflow profile

Soldering ramp-up time (Pb-FREE).

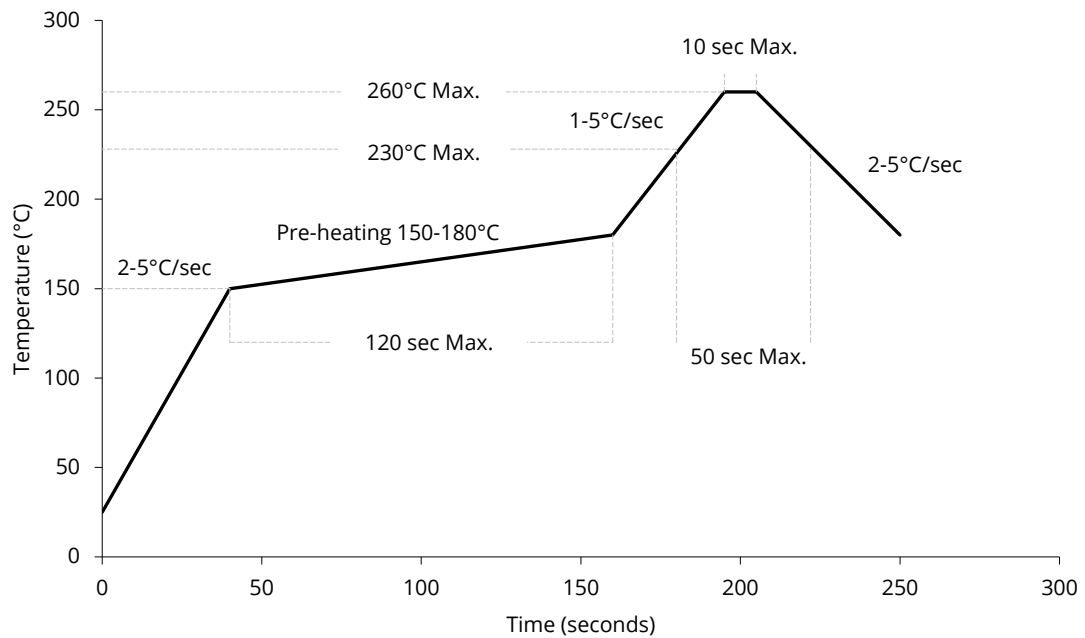

Note: Soldering paste with the melting point at 230°C is recommended.

SMT instruction

Problems caused by improper selection of collet

Choosing the right collet is important in ensuring product quality after SMT. LEDs are different from other electronic components, as they are not only concerned with electrical output but also optical output. This characteristic makes LEDs more fragile in the process of SMT. If the collet's lowering height is not well set, it will bring damage to the gold wire at the time of collet's pick-and-place process which can cause the LED to not illuminate, flicker or contribute to other quality problems, some of which may not be immediately detectable.

Collet selection

During SMT, please choose the collet that has larger outer diameter than the lighting area of lens, in order to avoid damage the gold wire inside the LED. Different collets fit for different products, please refer to the following figures below.

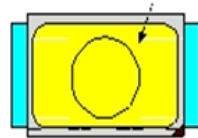

OK

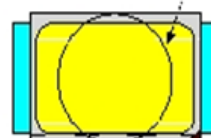

NOT OK – COLLET TOO SMALL

Setting the height of the collet is crucial in order to avoid damage to the top view SMD. If the collet setting is set to too low of an altitude, the collet will press down on the SMD, causing damage or breakage to the encapsulant and cause distortion or breakage of the gold wire.

Other notes of caution

- No pressure should be exerted to the epoxy shell of the SMD under high temperature.
- Do not scratch or wipe the lens since the lens and gold wire inside are rather fragile and cross out easy to break.
- LED should be used as soon as possible when being taken out of the original package, and should be stored in anti-moisture and anti-ESD package.
- This usage and handling instructions are for reference only.

Tape and reel specifications

Tape dimensions (unit: mm)

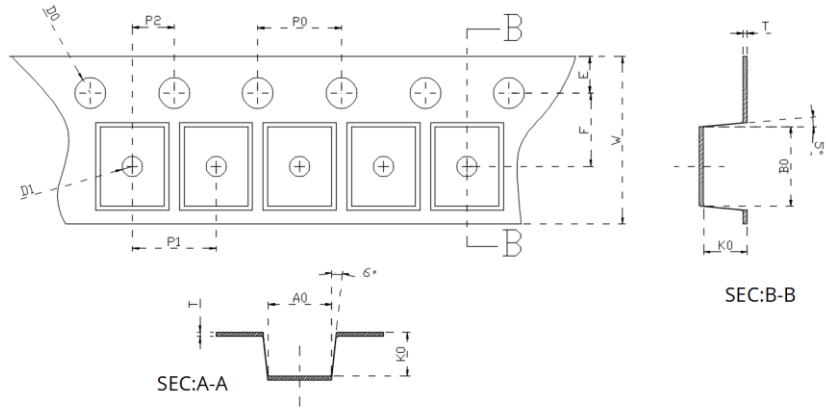

Code	W	T	D1	E	F	D0
Value	8.000	0.180	1.000	1.750	3.500	1.600
Tolerance	±0.100	±0.020	±0.100	±0.100	±0.100	±0.100
Code	P0	P1	P2	A0	B0	K0
Value	4.000	4.000	2.000	3.250	3.400	0.850
Tolerance	±0.100	±0.100	±0.100	±0.100	±0.100	±0.100

Tape layout

Not drawn to scale.

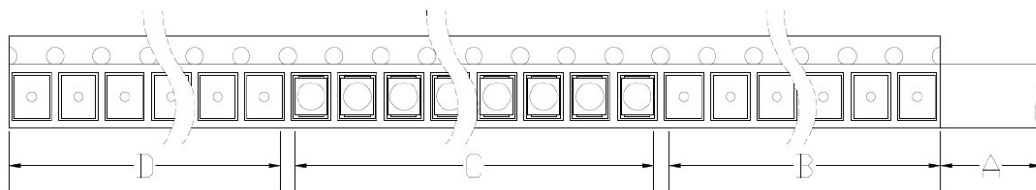

- A: Cover tape, 300mm;
- B: Empty leader, 200mm;
- C: LED, 5000pcs;
- D: Empty trailer, 200mm.

Tape and reel specifications

Reel dimensions top (unit: mm)

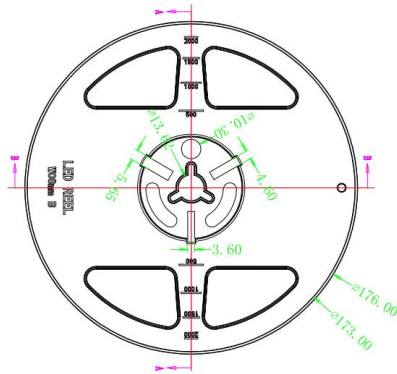

Reel dimensions bottom (unit: mm)

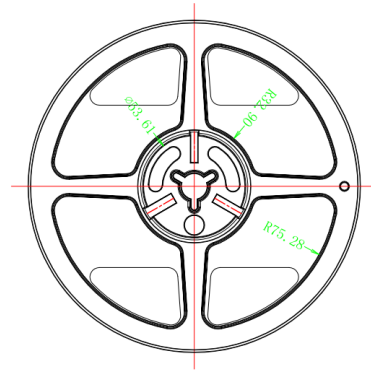

Reel dimensions side (unit: mm)

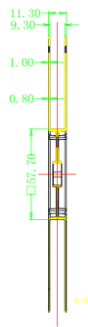

Feeding direction

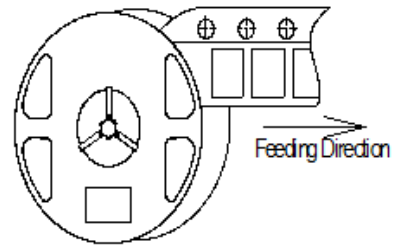

Box packaging

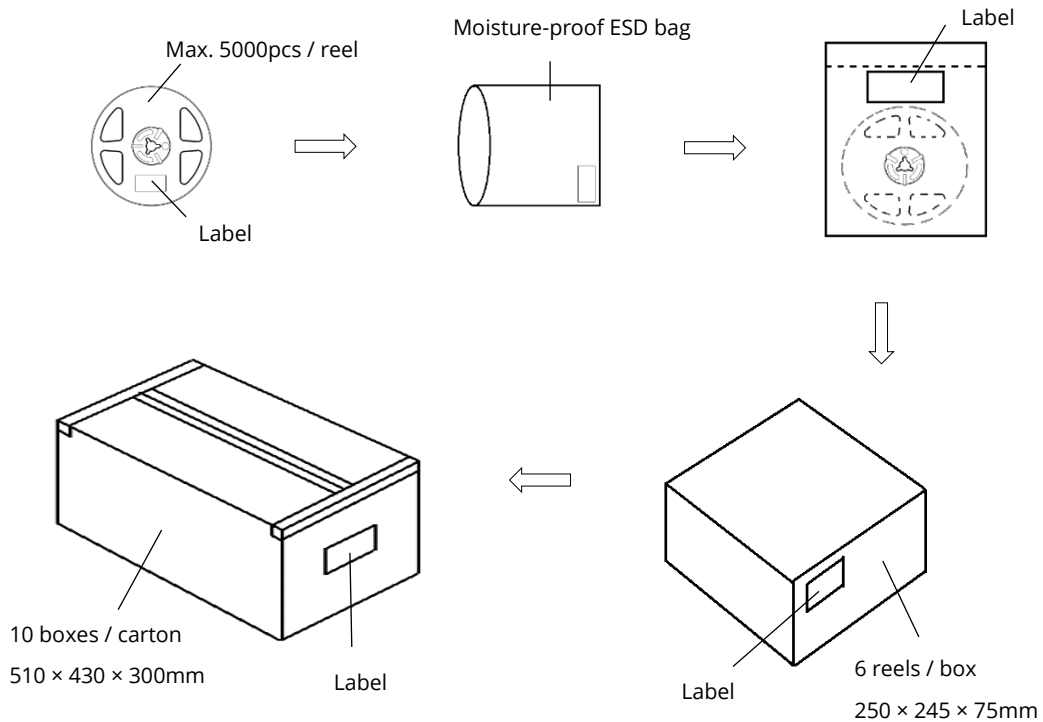

- Reeled products (max 5000pcs / reel) are packed in a moisture-proof bag along with a moisture desiccant pack.
- Each inner box contains up to 6 moisture-proof bag (total maximum number of SMDs is 30000pcs). Box package size: 250 mm × 245 mm × 75 mm.
- Each outer package contains 10 inner boxes. Box size: 510 mm × 430 mm × 300 mm.
- Outer package is sealed with protective bubble wrap and foam. (Part numbers, lot numbers, quantity should appear on the label on the moisture-proof bag, part numbers).
- This packaging merely intended as a reference for standard quantity orders only – please note that actual packaging can differ depending on the order circumstances.

About Yujileds



The Yuji story

Yuji started with LED phosphor materials in 2006, and today we are known for nitride red LED phosphor with superior brightness and stability in the world. With the rapid growth in LED industry during the past years, we have serviced over 260 business customers in over 33 different countries or regions, and established subsidiaries or distributors in 6 locations including China, US, UK and Japan, now we are reaching the global markets with the full coverage efficiently.

Our capabilities and achievements

In Yujileds®, we are a group of people passionate in creating the maximum value for customers. Dedicated to developing LED phosphor, LED light source and final products, we have accumulated unique experience in different projects. Nowadays, over 30 experts are gathered in a variety of areas including but not limited to semiconductor, chemistry, optics, photoelectricity, circuitry, materials and color science.

In commercial markets, we have been dedicating to providing comprehensive solutions for specific applications by deeply understanding these markets. Our goal is not only to offer an LED product simply but is to grow with customers and share the success of a business.

Main website: www.yujiintl.com

Find the comprehensive introduction of Yuji company and our insights into a variety of advanced technologies and applications.

Contact: info@yujigroup.com

Subordinative website: www.yujileds.com

Find more about our products, technical posts, featured support and service, blogs, news and whatever interesting and practical information.

Contact: contact@yujileds.com

Online shop: store.yujiintl.com

Find your favorite Yujileds® products with outstanding quality, fast shipment and superb sale service.

Contact: webstore@yujigroup.com