



YJ-BC-5555MX-G02

Surface Mount Device

Applications

- High-end architectural lighting
- Photographic/broadcast lighting
- Photoelectric device and relevant research

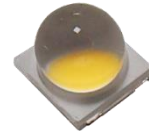

Features

- Industrial highest CRI performance
- 60° optical lens
- 5.5mm × 5.5mm package
- TLCI & TM-30 specified
- SimpleBinning solution

[About Yujileds[®]](#)

Document Number: YJWJ070

Rev Version: 2.0

P3190004.00

Table of Contents

General description	3
Ordering information	6
Characteristics	7
Electrical-optical characteristics.....	7
Absolute maximum ratings	8
Chromaticity group and diagram	9
Chromaticity bins & coordinates	9
CIE 1931 diagram.....	9
Reliability	10
Package material and dimension.....	11
Package layout.....	11
Package materials.....	11
Characteristic graph	12
Typical spectral power distribution	12
Characteristic graph	13
Forward current.....	13
- Vs. forward voltage	13
- Vs. relative luminous flux	13
- Vs. relative chromaticity shift.....	14
- Vs. absolute chromaticity shift.....	14
- Derating based on solder point	14
Solder point temperature.....	15
- Vs. forward voltage	15
- Vs. relative chromaticity shift.....	15
- Vs. absolute chromaticity shift.....	15
Spatial distribution	16
Solder and reflow profile	17
Recommended solder pad layout.....	17
Reflow profile.....	17
SMT instruction	18

Problems caused by improper selection of collet.....	18
Collet selection.....	18
Other notes of caution.....	18
Tape and reel specifications	19
Tape and reel specifications	20
Box packaging	21
About Yujileds	22

General description

The 5555 series LED is the combination of a typical SMD (Surface Mounted Device) LED with a silicon lens. With Yuji phosphor technology inside, all 5555 series LEDs are defined as CRI 97 performance. With the PCT lead frame, optimized LED phosphor solution and silicon lens, the 5555 series is robust for long-time working. It offers not only promising maintenance of brightness, but also the consistent color which is required critically in many different applications with excellent **Reliability**.



The 60° lens offers a significant effect for focused light with increased illuminance compared to a standard 120° SMD LED. And the high color rendition feature with accurate color consistency makes the 5555 series LED an ideal solution for photographic and cinematography lighting for creating the “hard light”.

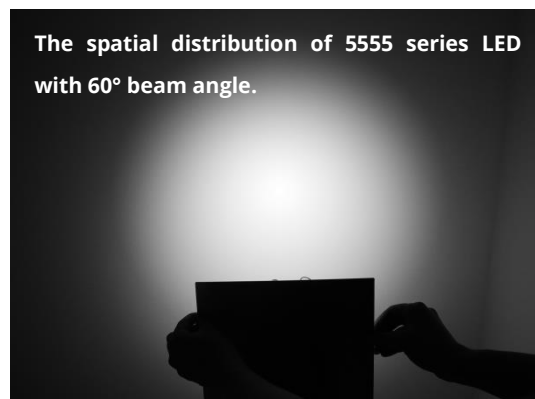
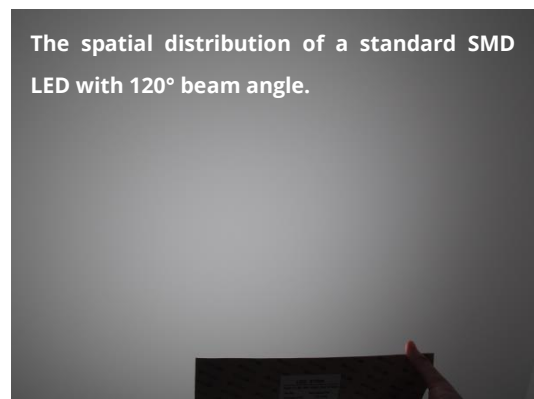
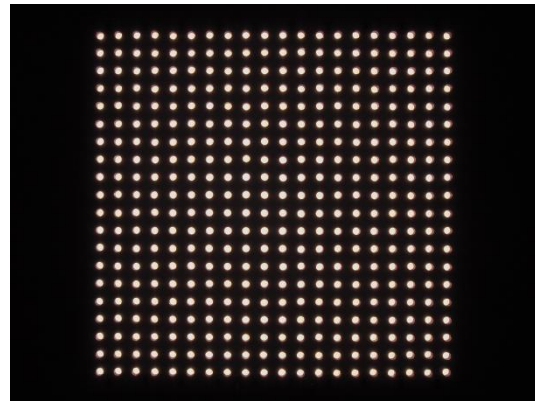

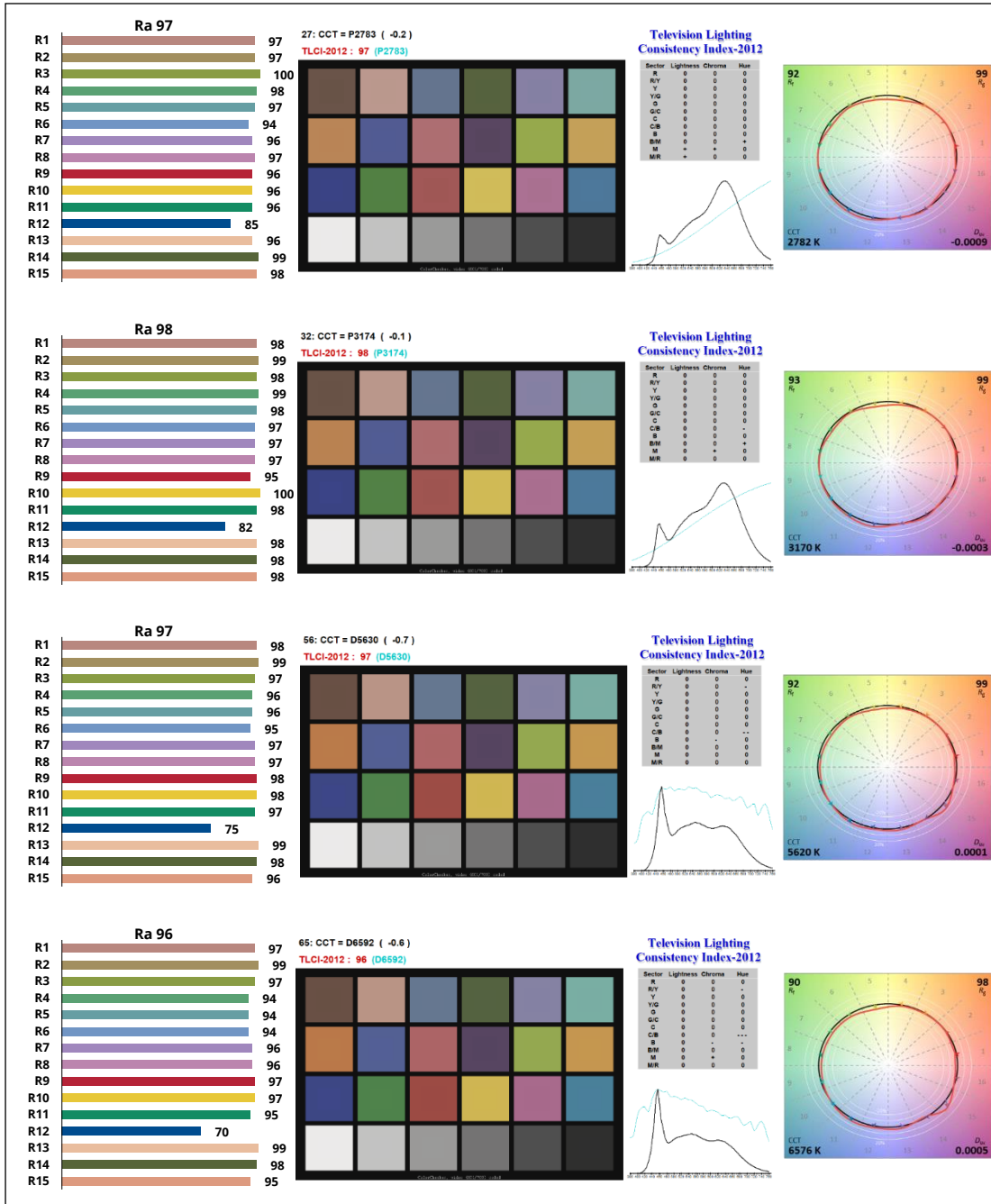

The BC series 5555 LED also supports the unique service/certification by Yujileads® as described below.

**TM-30-18 specification**

The most advanced colorimetric for color rendition, widely recognized as the successor of CRI.

**TLCI specification**

Based on the Macbeth ColorChecker, for evaluating the colorimetric quality of the broadcast lighting.

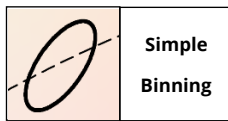
**SimpleBinning specification**

Simplify the chromaticity binning with TrueChroma data support to provide the most economical, simple, and practical solution to customers.

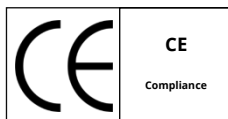
**RoHS 2011/65/EU compliance****CE compliance****REACH compliance (Phosphor)**

Ordering information

PART NUMBER	PRODUCT CODE	CCT	CHROMATICITY BINS	VOLTAGE RANGE
YJ-BC-5555MX-G02-27	P3190004.27	2700K	27L, 27R	0.1V
YJ-BC-5555MX-G02-32	P3190004.32	3200K	29M, 31M, 32M	0.1V
YJ-BC-5555MX-G02-56	P3190004.56	5600K	49M, 52M, 55M, 58M	0.1V
YJ-BC-5555MX-G02-65	P3190004.65	6500K	65L, 65R	0.1V
YJ-BC-5555MX-G02-XX	P3190004.XX	Custom	-	0.1V

Characteristics

Electrical-optical characteristics ($T_A = 25^\circ\text{C}$, 150mA)

PARAMETER	SYMBOL	VALUE			UNIT	TOLERANCE
		MIN.	TYP.	MAX.		
Forward voltage	V_F	3.0	-	3.4	V	± 0.05
Luminous Flux	Φ_{2700K}	45	-	50	lm	-
	Φ_{3200K}	45	-	50		
	Φ_{5600K}	50	-	55		
	Φ_{6500K}	50	-	55		
Correlated color temperature¹	CCT_{2700K}	2580	2700	2820	K	-
	CCT_{3200K}	2900	3200	3320		
	CCT_{5600K}	4800	5600	6000		
	CCT_{6500K}	6100	6500	6900		
Color rendering index	R_a	95 ²	-	-	-	± 1
TCS R9 (CRI red)	R_9	-	90	-	-	-
Fidelity index³	R_f	-	92	-	-	-
Gamut index³	R_g	-	100	-	-	-
TLCI 2012⁴	-	-	97	-	-	-
Reverse current	I_r	-	-	1	μA	$\pm 0.1 (V_r = 5V)$
View angle	$2\theta_{1/2}$	-	60	-	Deg	± 3

1. Yujileds® promises the chromaticity coordinate tolerance of ± 0.0015 (CIE 1931 x,y) based on Yuji standard equipment shall prevail.
2. R_a typical 95 at 6500K.
3. Defined by the IES TM-30-18 method, this data is for trial.
4. Defined by the EBU, TLCI is the abbreviation of Television Lighting Consistency Index, this data is for trial.
5. This data is for reference only.

Characteristics

Absolute maximum ratings ($T_A = 25^\circ\text{C}$)

PARAMETER	SYMBOL	LIMIT	UNIT
Power Consumption	P_D	630	mW
DC Forward Current (pulsed)¹	I_{FP}	360^2	mA
DC Forward Current	I_F	180	mA
Reverse Voltage	V_R	5	V
Junction Temperature	T_j	125	$^\circ\text{C}$
Solder Point Temperature³	T_s	105	$^\circ\text{C}$
Operating Temperature	T_{opr}	-40 ~ +85	$^\circ\text{C}$
Storage Temperature	T_{stg}	-30 ~ +85	$^\circ\text{C}$
Soldering Temperature	T_{sol}	190 ± 5	$^\circ\text{C}$
Reflow Cycles Allowed	-	2	-

1. Pulse width $\leq 0.1\text{ms}$, duty $\leq 1/10$.
2. Theoretical data.
3. See page [Package material and dimension](#).

Chromaticity group and diagram

Chromaticity bins & coordinates

CCT	BIN	CIE 1931 COORDINATES							
		X0	Y0	X1	Y1	X2	Y2	X3	Y3
2700K	27L	0.4542	0.4166	0.4459	0.4005	0.4552	0.4025	0.4642	0.4185
	27R	0.4642	0.4185	0.4552	0.4025	0.4652	0.4043	0.4749	0.4203
3200K	29M	0.4371	0.4105	0.4297	0.3945	0.4403	0.3985	0.4483	0.4143
	31M	0.4269	0.4069	0.4200	0.3909	0.4297	0.3945	0.4371	0.4105
	33M	0.4194	0.4042	0.4130	0.3882	0.4200	0.3909	0.4269	0.4069
5600K	49M	0.3450	0.3610	0.3440	0.3420	0.3502	0.3473	0.3517	0.3657
	52M	0.3450	0.3610	0.3440	0.3420	0.3344	0.3330	0.3347	0.3520
	55M	0.3260	0.3430	0.3270	0.3250	0.3344	0.3330	0.3347	0.3520
	58M	0.3205	0.3385	0.3224	0.3210	0.3270	0.3250	0.3260	0.3430
6500K	65L	0.3067	0.3235	0.3088	0.3121	0.3143	0.3178	0.3128	0.3295
	65R	0.3128	0.3295	0.3143	0.3178	0.3205	0.3241	0.3192	0.3359

CIE 1931 diagram

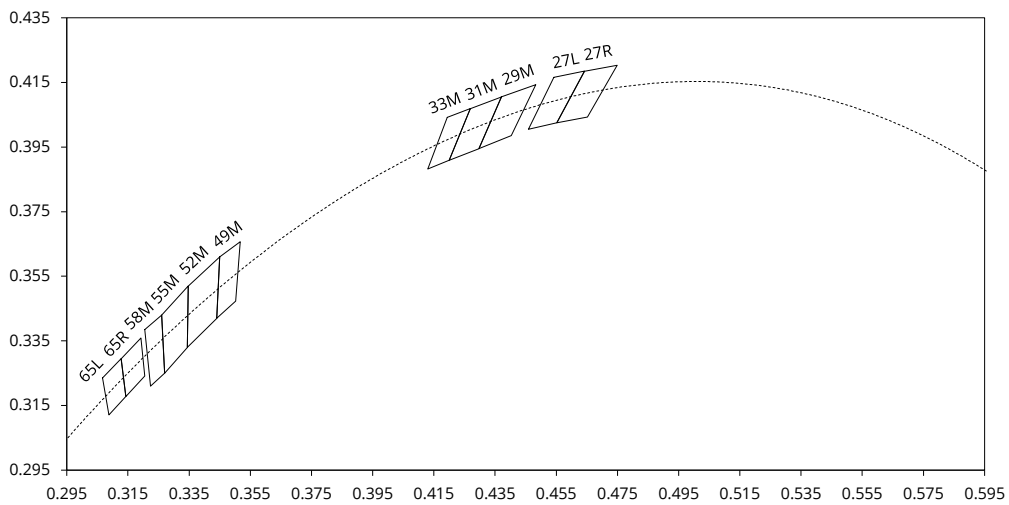

Reliability¹

$T_s = 55^\circ\text{C}$, $I_F = 300\text{mA}$, $\text{RH} < 65\%$, estimated L70 > 54000 hours²

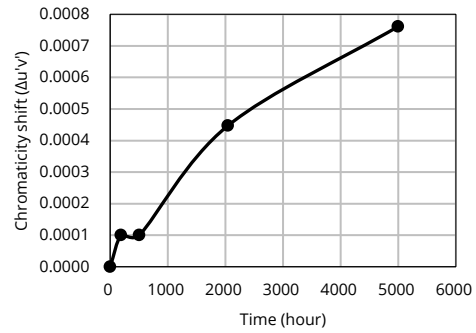
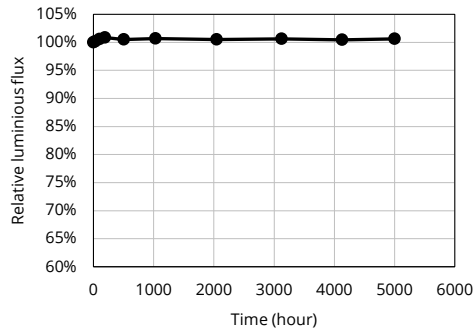

1. Data from Yujileds® lab, based on the average test of YJ-BC-5555HX-G02-56.
2. Yujileds® reserves all the right for final explanation of reliability.

Package material and dimension

Package layout

All dimensions in mm, tolerance unless mentioned is ± 0.1 mm.

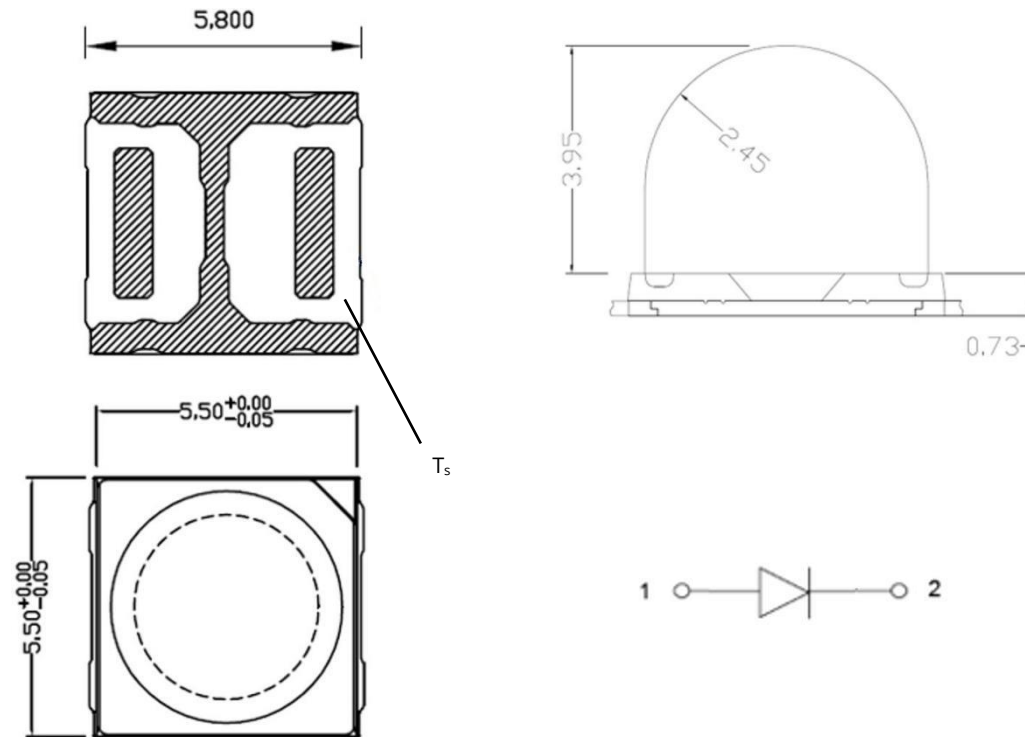

Package materials

ITEM	DESCRIPTION
Die material	InGaN
Lead frame material	PCT
Encapsulant resin material	Silicon + Phosphor
Electrodes material	Silver-plated copper

Characteristic graph

Typical spectral power distribution (normalized)

All characteristic curves are for reference only and not guaranteed.

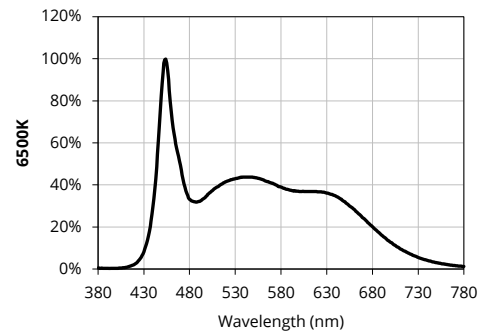
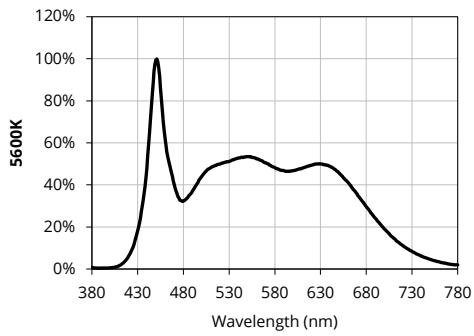
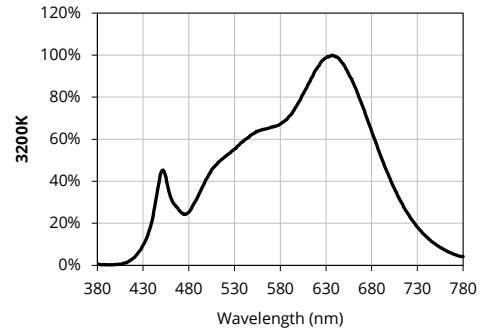
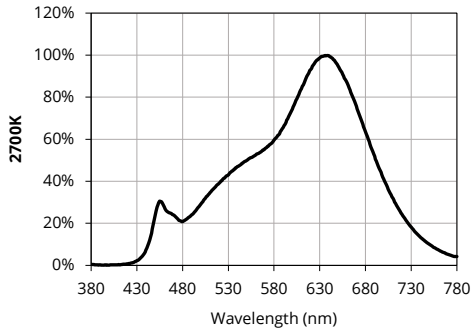

Characteristic graph

Forward current

All characteristic curves are for reference only and not guaranteed.

Vs. forward voltage

($T_A = 25^\circ\text{C}$)

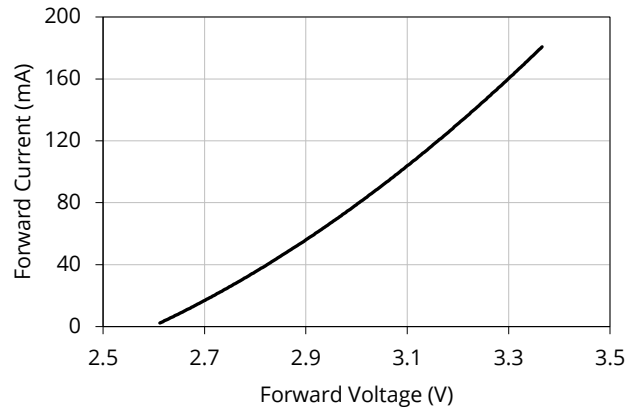

Vs. relative luminous flux

($T_A = 25^\circ\text{C}$)

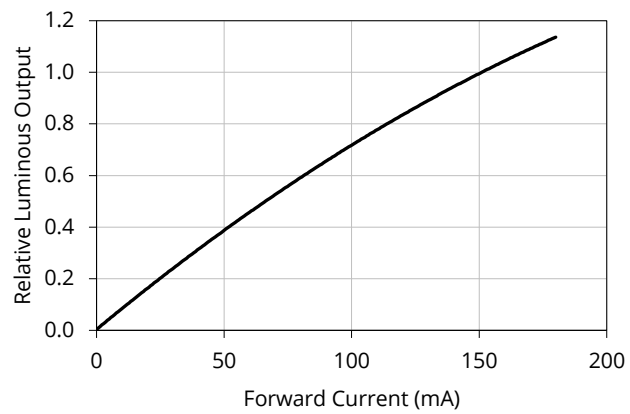

Characteristic graph

Forward current (continued)

All characteristic curves are for reference only and not guaranteed.

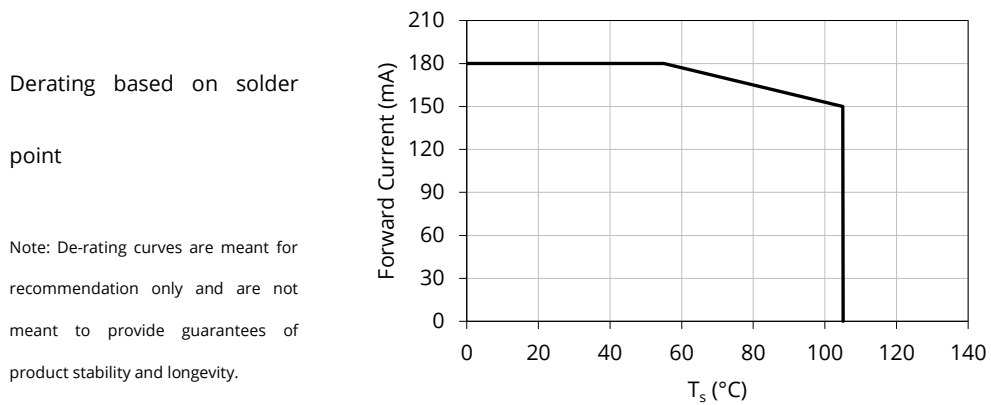
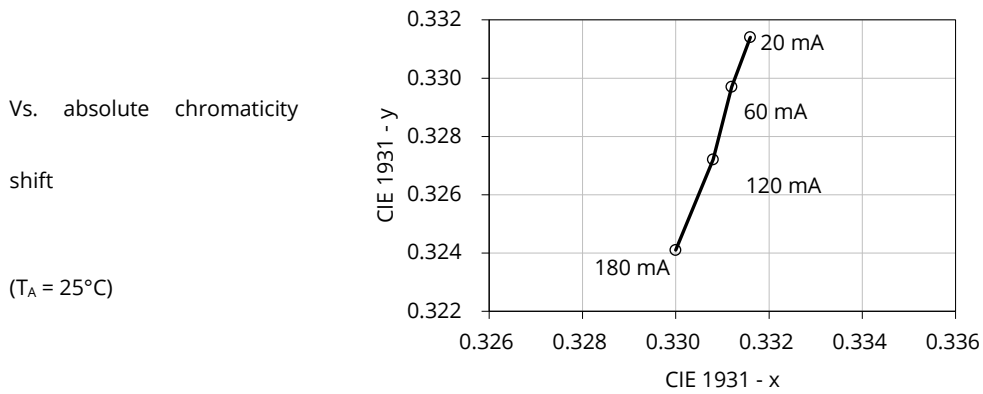
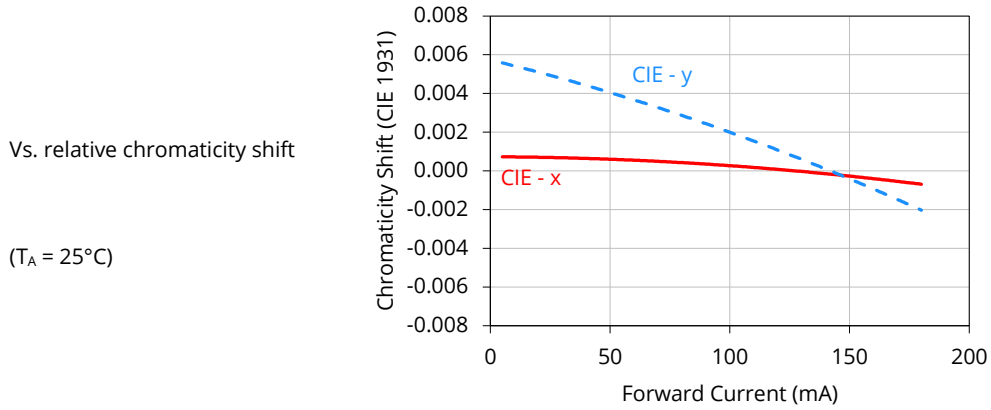

Solder point temperature (T_s)

All characteristic curves are for reference only and not guaranteed.

Vs. forward voltage

($I_F = 150\text{mA}$)

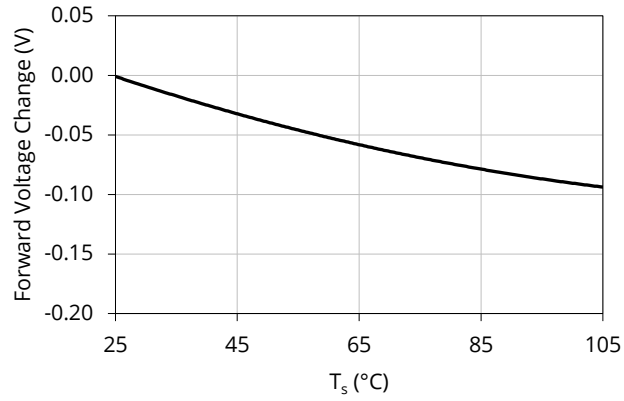

Vs. relative chromaticity shift

(5600K, $I_F = 150\text{mA}$)

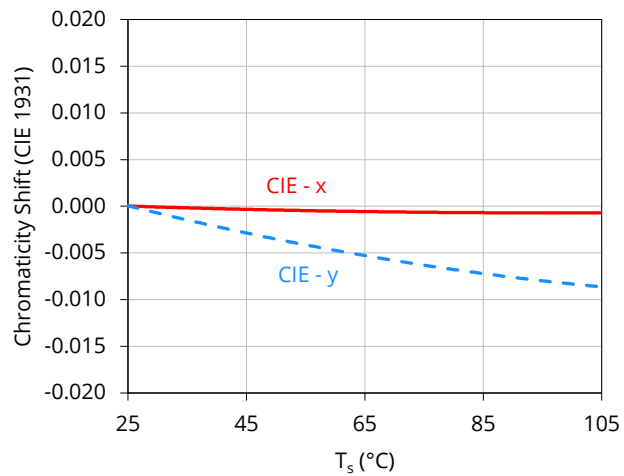

Vs. absolute chromaticity shift

(5600K, $I_F = 150\text{mA}$)

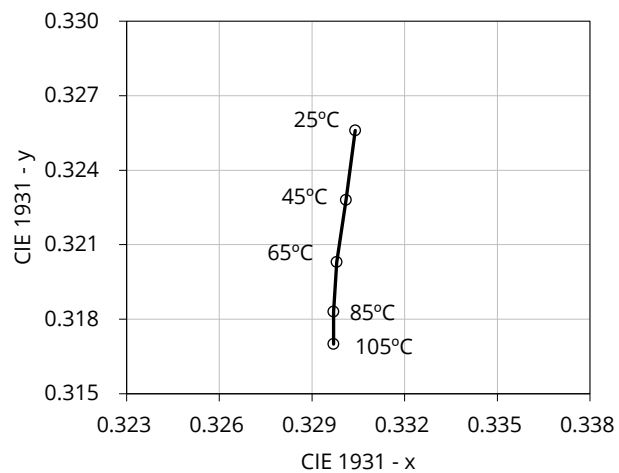

Characteristic graph

Spatial distribution ($T_A = 25^\circ\text{C}$, $I_F = 150\text{mA}$)

All characteristic curves are for reference only and not guaranteed.

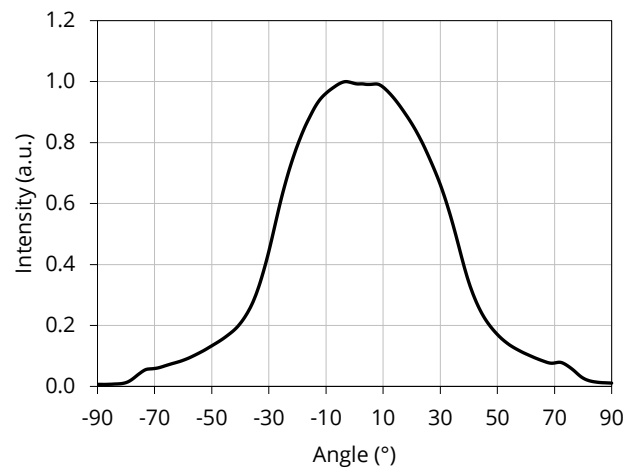

Solder and reflow profile

Recommended solder pad layout

All dimensions in mm, tolerance unless mentioned is $\pm 0.1\text{mm}$.

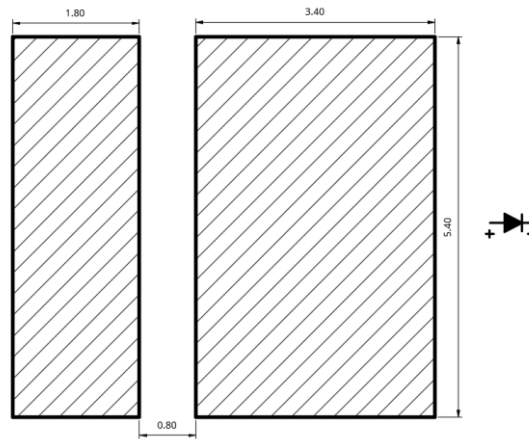

Reflow profile

Soldering ramp-up time (Pb-FREE).

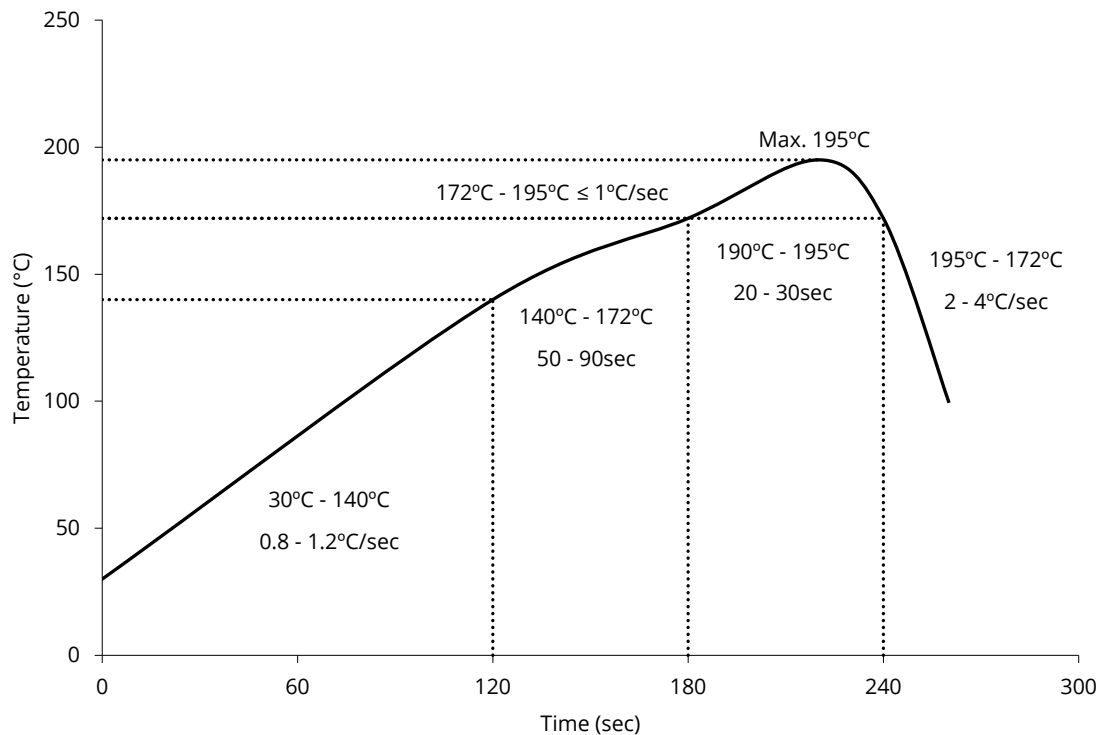

Note: Soldering paste with the melting point at 170°C is recommended.

SMT instruction

Problems caused by improper selection of collet

Choosing the right collet is important in ensuring product quality after SMT. LEDs are different from other electronic components, as they are not only concerned with electrical output but also optical output. This characteristic makes LEDs more fragile in the process of SMT. If the collet's lowering height is not well set, it will bring damage to the gold wire at the time of collet's pick-and-place process which can cause the LED to not illuminate, flicker or contribute to other quality problems, some of which may not be immediately detectable.

Collet selection

During SMT, please choose the collet that has larger outer diameter than the lighting area of lens, in order to avoid damage the gold wire inside the LED. Different collets fit for different products, please refer to the following figures below.

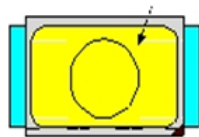

OK

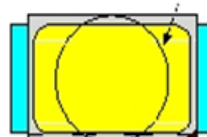

NOT OK – COLLET TOO SMALL

Setting the height of the collet is crucial in order to avoid damage to the top view SMD. If the collet setting is set to too low of an altitude, the collet will press down on the SMD, causing damage or breakage to the encapsulant and cause distortion or breakage of the gold wire.

Other notes of caution

- No pressure should be exerted to the epoxy shell of the SMD under high temperature.
- Do not scratch or wipe the lens since the lens and gold wire inside are rather fragile and cross out easy to break.
- LED should be used as soon as possible when being taken out of the original package, and should be stored in anti-moisture and anti-ESD package.
- This usage and handling instructions are for reference only.

Tape and reel specifications

Tape dimensions (unit: mm)

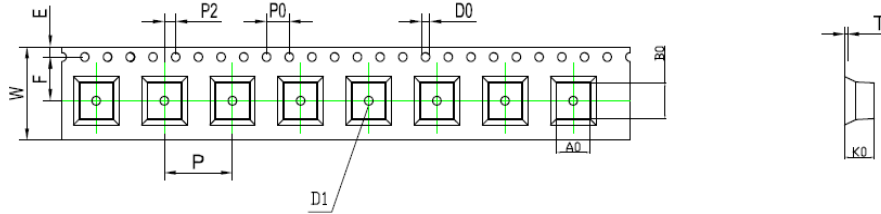

Symbol	A0	B0	K0	P0	P	P2	Length / Reel
Spec	5.80 ±	6.10 ±	4.90 ±	4.00 ±	12.0 ±	2.00 ±	4000
	0.10	0.10	0.10	0.10	0.10	0.10	
Symbol	W	T	E	F	D0	D1	-
Spec	16.0 ±	0.40 ±	1.75 ±	7.50 ±	1.50 ±	1.50 ±	-
	0.30	0.05	0.10	0.10	0.10	0.10	

Tape layout

Not drawn to scale.

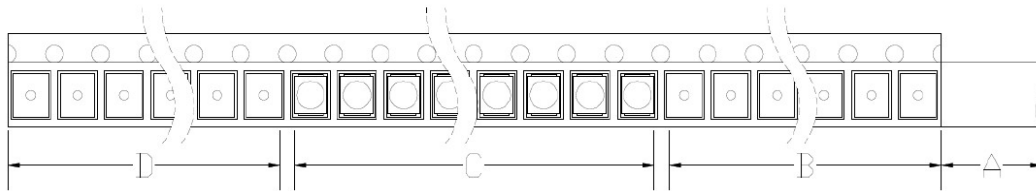

- A: Cover tape, 300mm;
- B: Empty leader, 600mm;
- C: LED, 1000pcs;
- D: Empty trailer, 600mm.

Tape and reel specifications

Reel dimensions top (unit: mm)

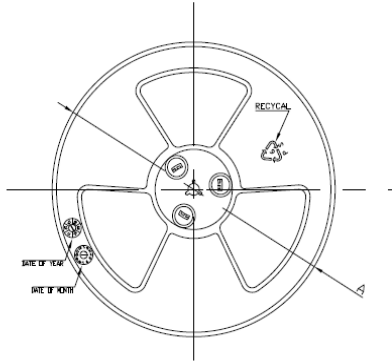

Reel dimensions side (unit: mm)

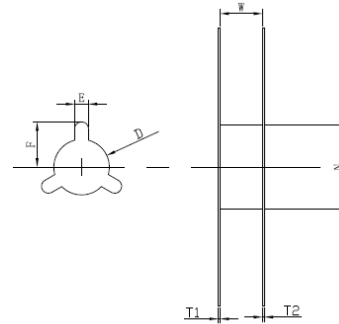

Feeding direction

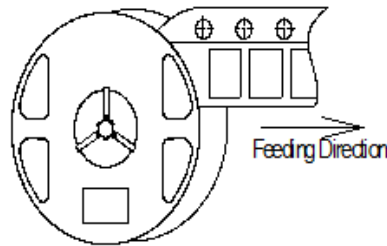

Spec	12	16	24	32	44	56	72
E ± 0.5	2.3	2.3	2.3	2.3	2.3	2.3	2.3
F ± 0.5	10.75	10.75	10.75	10.75	10.75	10.75	10.75
W ± 0.2	12.4	16.4	24.5	32.4	44.4	56.4	72.4
T1 ± 0.3	2.2	2.2	2.2	2.2	2.2	2.2	2.2
T2 ± 0.3	2.2	2.2	2.2	2.2	2.2	2.2	2.2
A ± 0.2	Ø330	Ø330	Ø330	Ø330	Ø330	Ø330	Ø330
N ± 0.3	Ø100	Ø100	Ø100	Ø100	Ø100	Ø100	Ø100
D ± 0.3	13.3	13.3	13.3	13.3	13.3	13.3	13.3

Box packaging

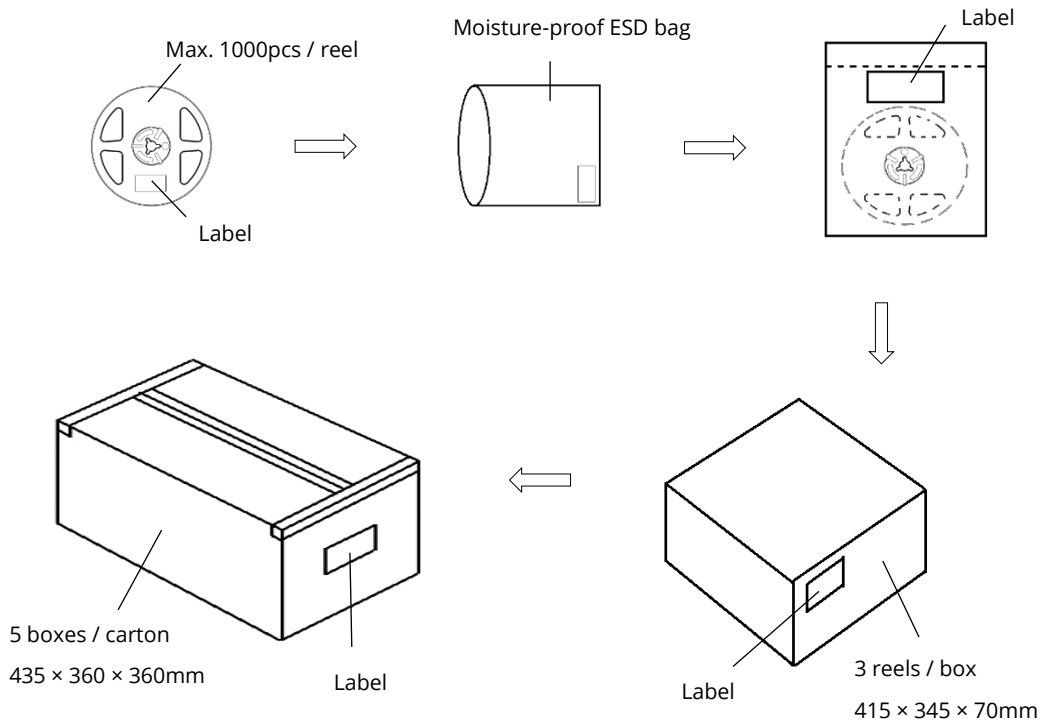

- Reeled products (max 1000 pcs / reel) are packed in a moisture-proof bag along with a moisture desiccant pack.
- Each inner box contains up to 3 moisture-proof bag (total maximum number of SMDs is 3000pcs). Box package size: 415 mm x 345 mm x 70 mm.
- Each outer package contains 5 inner boxes. Box size: 435 mm x 360 mm x 360 mm.
- Outer package is sealed with protective bubble wrap and foam. (Part numbers, lot numbers, quantity should appear on the label on the moisture-proof bag, part numbers).
- This packaging merely intended as a reference for standard quantity orders only – please note that actual packaging can differ depending on the order circumstances.

About Yujileds



The Yuji story

Yuji started with LED phosphor materials in 2006, and today we are known for nitride red LED phosphor with superior brightness and stability in the world. With the rapid growth in LED industry during the past years, we have serviced over 260 business customers in over 33 different countries or regions, and established subsidiaries or distributors in 6 locations including China, US, UK and Japan, now we are reaching the global markets with the full coverage efficiently.

Our capabilities and achievements

In Yujileds®, we are a group of people passionate in creating the maximum value for customers. Dedicated to developing LED phosphor, LED light source and final products, we have accumulated unique experience in different projects. Nowadays, over 30 experts are gathered in a variety of areas including but not limited to semiconductor, chemistry, optics, photoelectricity, circuitry, materials and color science.

In commercial markets, we have been dedicating to providing comprehensive solutions for specific applications by deeply understanding these markets. Our goal is not only to offer an LED product simply but is to grow with customers and share the success of a business.

Main website: www.yujiintl.com

Find the comprehensive introduction of Yuji company and our insights into a variety of advanced technologies and applications.

Contact: info@yujigroup.com

Subordinative website: www.yujileds.com

Find more about our products, technical posts, featured support and service, blogs, news and whatever interesting and practical information.

Contact: contact@yujileds.com

Online shop: store.yujiintl.com

Find your favorite Yujileds® products with outstanding quality, fast shipment and superb sale service.

Contact: webstore@yujigroup.com