

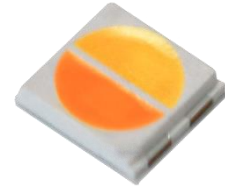

YJ-BC-3032-G03

Surface Mount Device



Applications

- High-end architectural lighting
- Photographic/broadcast lighting
- Human-centric lighting
- Photoelectric device and relevant research

Features

- Industrial highest CRI performance
- 3.0mm × 3.2mm package
- TLCI & TM-30 specified
- SimpleBinning solution

[About Yujileds[®]](#)

Document Number: YJWJ097

Rev Version: 2.0

P3200006.00

Table of Contents

General description	2
Ordering information	6
Characteristics	7
Electrical-optical characteristics.....	7
Absolute maximum ratings	8
Chromaticity group and diagram	9
Chromaticity bins & coordinates	9
CIE 1931 diagram.....	9
Package material and dimension.....	8
Package layout.....	8
Package materials.....	8
Characteristic graph	8
Typical spectral power distribution	8
Forward current.....	9
- Vs. forward voltage	9
- Vs. relative luminous flux	9
- Vs. absolute chromaticity shift.....	10
- Derating based on solder point	10
Solder and reflow profile	11
Recommended solder pad layout.....	11
Reflow profile.....	11
SMT instruction	12
Problems caused by improper selection of collet.....	12
Collet selection.....	12
Other notes of caution.....	12
Tape and reel specifications	13
Box packaging	15
About Yujileds	16

General description

Tunable white, or saying bi-color LED, is not a novel concept on the market. For human-centric lighting or cinematography lighting which requires a tunable spectrum, bi-color LED is already widely applied in many products. So far, most tunable white LEDs on the market are separated single-white colors, however, considering some special projects which desire not only bi-color effect but also limited space of illumination, or high illuminating density, YUJILEDS® BC series 3032 LED will be a preferable option.

YUJILEDS® BC series 3032 SMD provides a high CRI and high efficacy solution with the specific design of 2-in-1. This compact layout offers easier diffusion capability because of the feature of closing to a spot source.

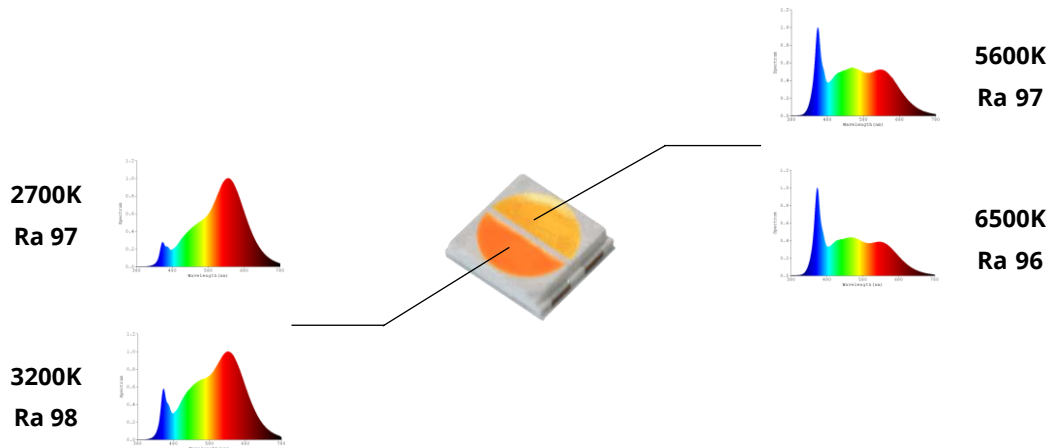

Compared with the designs of a PCB with standard bi-color LEDs and the 3032 LED, when assembling the LEDs as a high-density matrix, there will be a significant difference. Figure 7 simulates a specific case of 1 ft × 1ft panel with separated bi-color LEDs to achieve high density compared to the solution with 3032 LED. Apparently, the 3032 LED can not only achieve twice the power within the same limitation of size but provide easier electrical design.

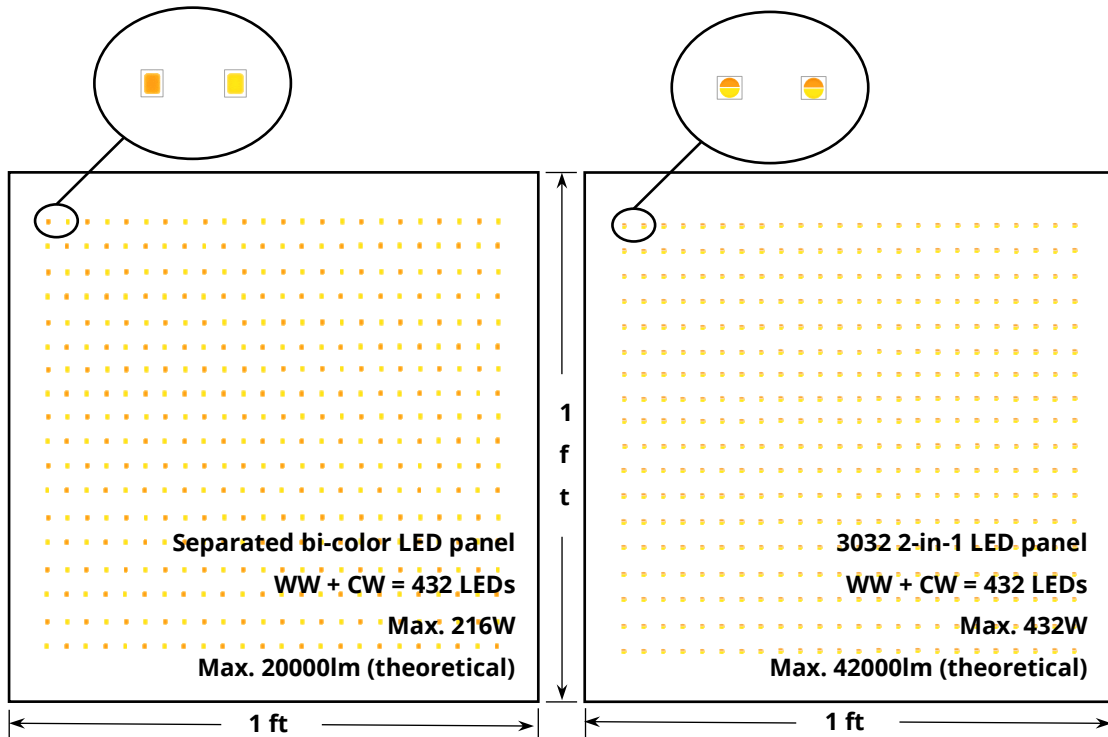

The BC series 3032 LED offers easier diffusion capability as well because of the feature of closing to a spot source, and it is friendly to design linear lighting fixtures because of the compact structure. A direct advantage is to reduce the PCB width for thinner or narrower side-emitting lights, with the same diffused effect compared to standard bi-color LEDs.

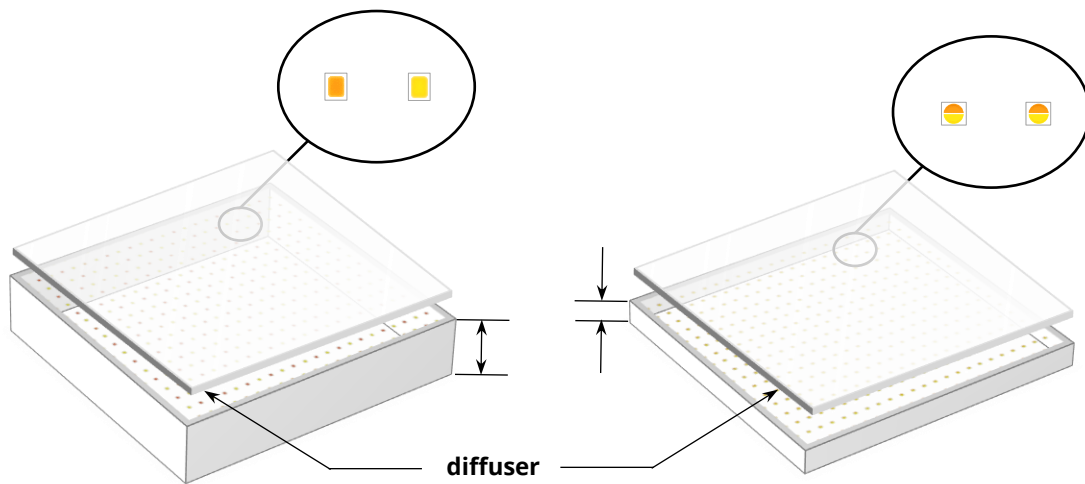

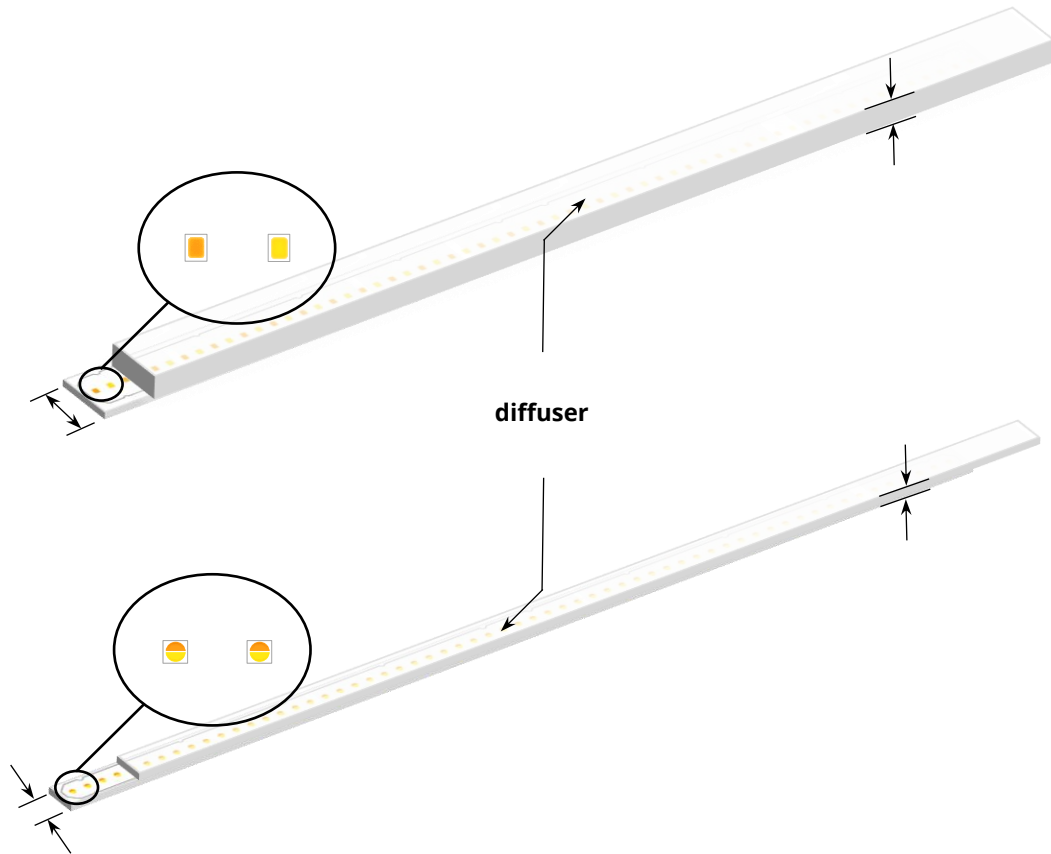

The BC series 3032 LED also supports the unique service/certification by Yujileds® as described below.



TM-30-18 specification

The most advanced colorimetric for color rendition, widely recognized as the successor of CRI.



TLCI specification

Based on the Macbeth ColorChecker, for evaluating the colorimetric quality of the broadcast lighting.

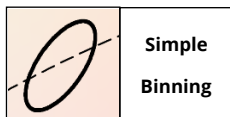

SimpleBinning specification

Simplify the chromaticity binning with TrueChroma data support to provide the most economical, simple, and practical solution to customers.

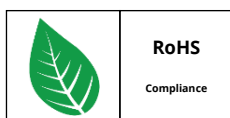

RoHS 2011/65/EU compliance

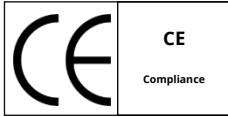

CE compliance



REACH compliance (Phosphor)

Ordering information

PART NUMBER	PRODUCT CODE	CCT	CHROMATICITY BINS	VOLTAGE RANGE
YJ-BC-3032-G03-2765	P3200006.26	2700K 6500K	27M 65M	0.1V
YJ-BC-3032-G03-3256	P3200006.35	3200K 5600K	32M 56M	0.1V
YJ-BC-3032-G03-XXXX	P3200006.XX	Custom	-	0.1V

Characteristics

Electrical-optical characteristics ($T_A = 25^\circ\text{C}$, 150mA)

PARAMETER	SYMBOL	VALUE			UNIT	TOLERANCE
		MIN.	TYP.	MAX.		
Forward voltage	V_F	2.8	-	3.4	V	± 0.05
Luminous Flux	Φ_{2700K}	40	-	45		
	Φ_{3200K}	45	-	50		
	Φ_{5600K}	50	-	57		-
	Φ_{6500K}	50	-	57		
Correlated color temperature¹	CCT_{2700K}	2550	-	2850		
	CCT_{3200K}	3050	-	3350	K	-
	CCT_{5600K}	5300	-	5900		
	CCT_{6500K}	6000	-	7000		
Color rendering index	R_a	95 ²	-	-		
TCS R9 (CRI red)	R_9	-	90	-	-	-
Fidelity index³	R_f	-	92	-	-	-
Gamut index³	R_g	-	100	-	-	-
TLCI 2012⁴	-	-	97	-	-	-
Reverse current	I_r	-	-	10	μA	$\pm 0.1 (V_r = 5V)$
View angle	$2\theta_{1/2}$	-	120	-	Deg	± 5

1. Yujileds® promises the chromaticity coordinate tolerance of ± 0.0015 (CIE 1931 x,y) based on Yuji standard equipment shall prevail.
2. R_a typical 95 at 6500K.
3. Defined by the IES TM-30-18 method, this data is for trial.
4. Defined by the EBU, TLCI is the abbreviation of Television Lighting Consistency Index, this data is for trial.

Characteristics

Absolute maximum ratings ($T_A = 25^\circ\text{C}$)

PARAMETER	SYMBOL	LIMIT	UNIT
Power Consumption	P_D	1200	mW
DC Forward Current (pulsed)¹	I_{FP}	300 ²	mA
DC Forward Current	I_F	200	mA
Reverse Voltage	V_R	5	V
Junction Temperature	T_j	125	$^\circ\text{C}$
Solder Point Temperature³	T_s	105	$^\circ\text{C}$
Operating Temperature	T_{opr}	-40 ~ +85	$^\circ\text{C}$
Storage Temperature	T_{stg}	-30 ~ +85	$^\circ\text{C}$
Soldering Temperature	T_{sol}	260 \pm 5	$^\circ\text{C}$
Reflow Cycles Allowed	-	2	-

1. Pulse width $\leq 0.1\text{ms}$, duty $\leq 1/10$.
2. Theoretical data.
3. See page [Package material and dimension](#).

Chromaticity group and diagram

Chromaticity bins & coordinates

CCT	BIN	CIE 1931 COORDINATES							
		X0	Y0	X1	Y1	X2	Y2	X3	Y3
2700K	27M	0.4562	0.4170	0.4477	0.4009	0.4631	0.4039	0.4727	0.4199
3200K	32M	0.4207	0.4047	0.4143	0.3887	0.4263	0.3931	0.4334	0.4091
5600K	56M	0.3247	0.3411	0.3253	0.3277	0.3358	0.3368	0.3360	0.3516
6500K	65M	0.3078	0.3245	0.3098	0.3131	0.3194	0.3230	0.3181	0.3349

CIE 1931 diagram

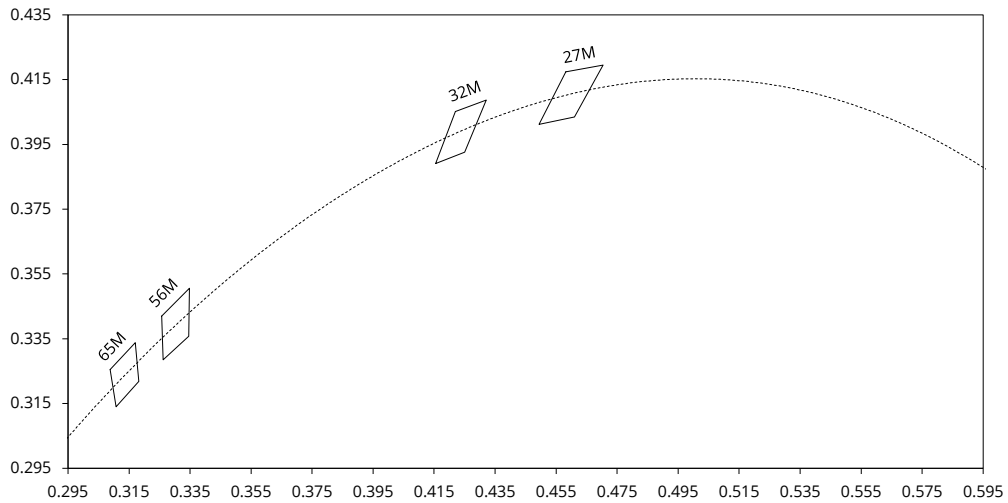

Package material and dimension

Package layout

All dimensions in mm, tolerance unless mentioned is ± 0.1 mm.

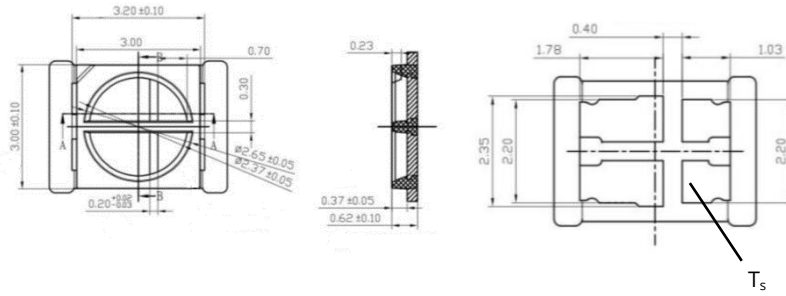

Package materials

ITEM	DESCRIPTION
Die material	InGaN
Lead frame material	PCT
Encapsulant resin material	Silicon + Phosphor
Electrodes material	Silver-plated copper

Characteristic graph

Typical spectral power distribution (normalized)

All characteristic curves are for reference only and not guaranteed.

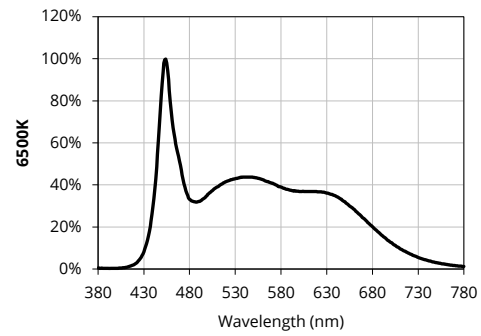
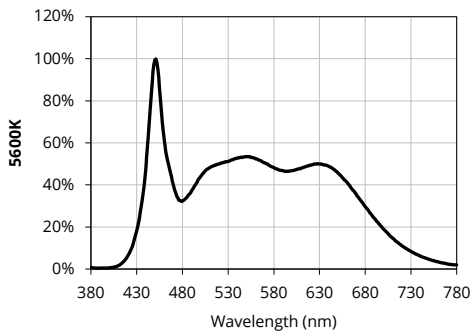
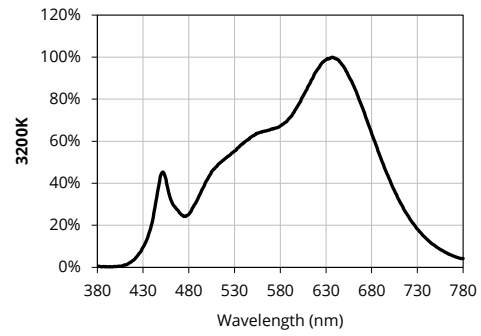
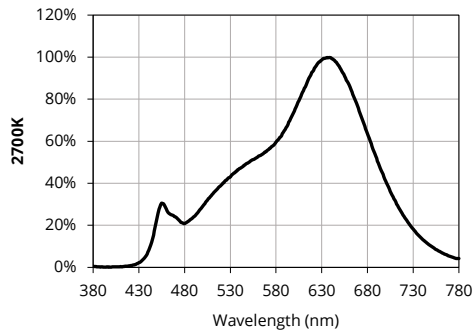

Characteristic graph

Forward current

All characteristic curves are for reference only and not guaranteed.

Vs. forward voltage

(T_A = 25°C)

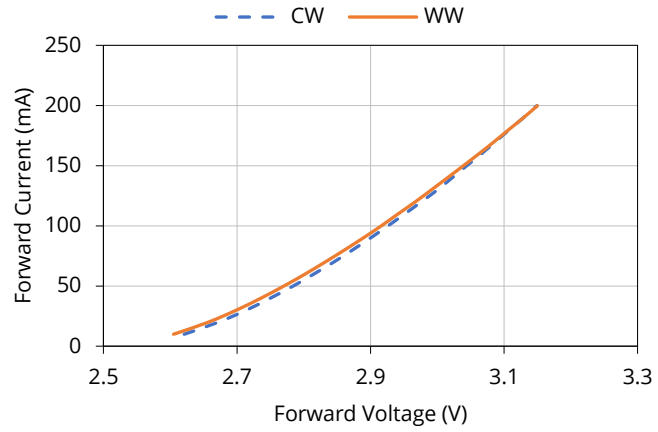

Vs. relative luminous flux

(T_A = 25°C)

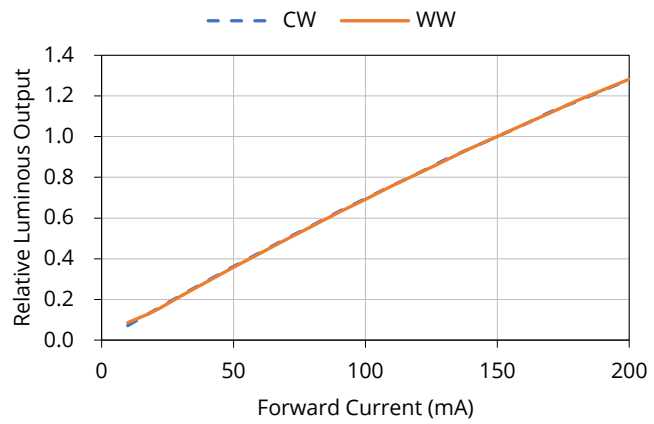

Characteristic graph

Forward current (continued)

All characteristic curves are for reference only and not guaranteed.

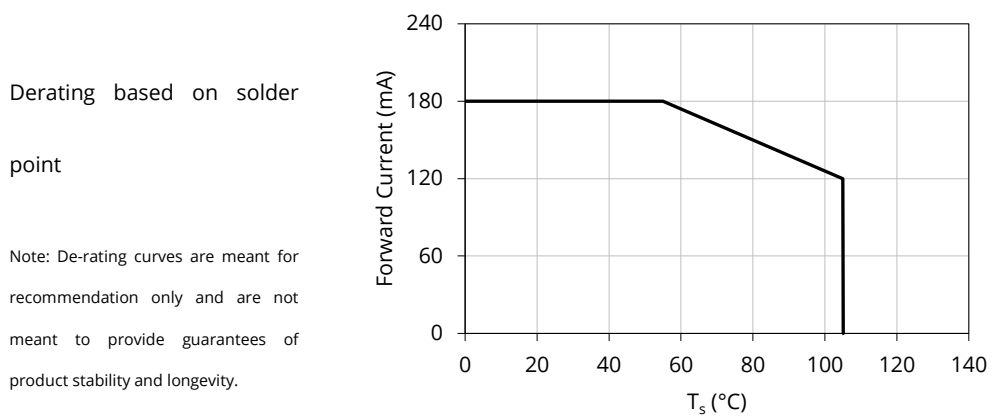
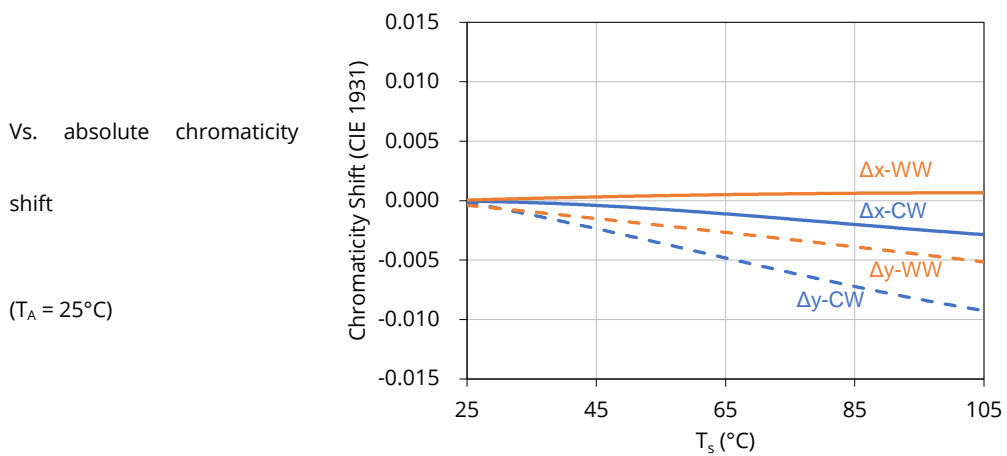
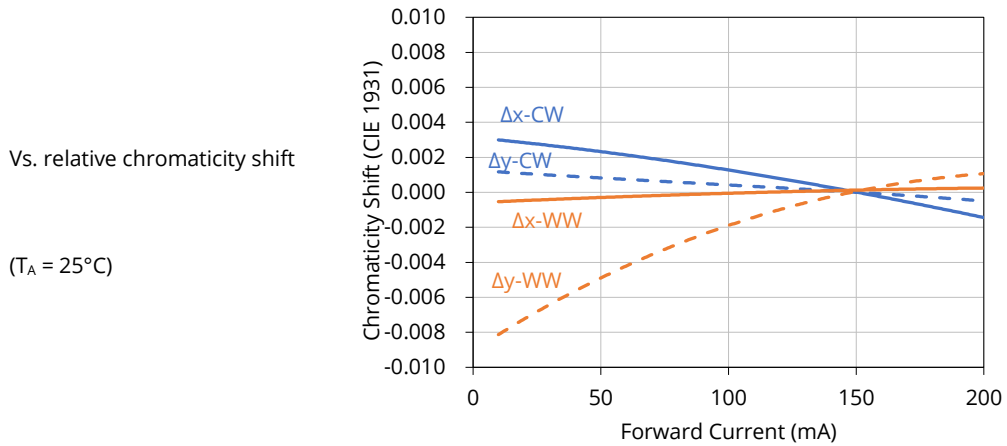

Solder and reflow profile

Recommended solder pad layout

All dimensions in mm, tolerance unless mentioned is ± 0.1 mm.

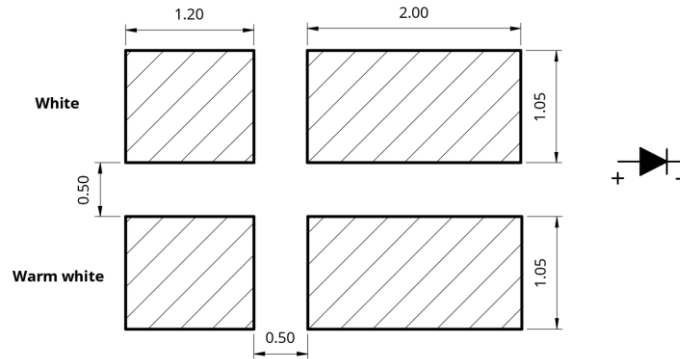

Reflow profile

Soldering ramp-up time (Pb-FREE).

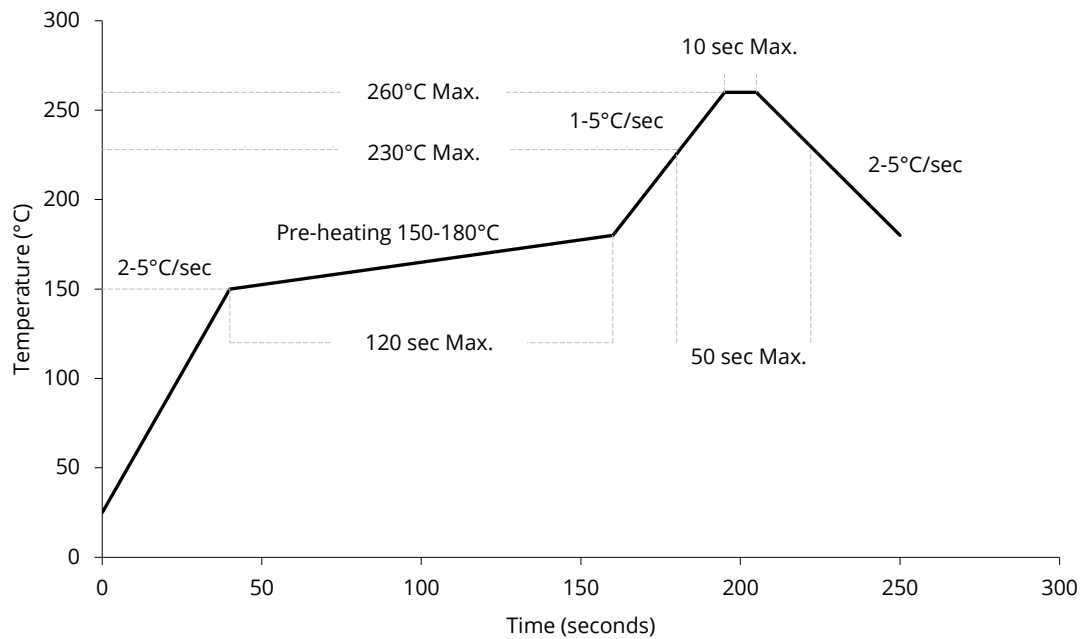

Note: Soldering paste with the melting point at 230°C is recommended.

SMT instruction

Problems caused by improper selection of collet

Choosing the right collet is important in ensuring product quality after SMT. LEDs are different from other electronic components, as they are not only concerned with electrical output but also optical output. This characteristic makes LEDs more fragile in the process of SMT. If the collet's lowering height is not well set, it will bring damage to the gold wire at the time of collet's pick-and-place process which can cause the LED to not illuminate, flicker or contribute to other quality problems, some of which may not be immediately detectable.

Collet selection

During SMT, please choose the collet that has larger outer diameter than the lighting area of lens, in order to avoid damage the gold wire inside the LED. Different collets fit for different products, please refer to the following figures below.

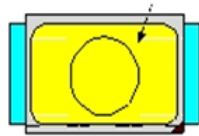

OK

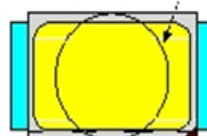

NOT OK – COLLET TOO SMALL

Setting the height of the collet is crucial in order to avoid damage to the top view SMD. If the collet setting is set to too low of an altitude, the collet will press down on the SMD, causing damage or breakage to the encapsulant and cause distortion or breakage of the gold wire.

Other notes of caution

- No pressure should be exerted to the epoxy shell of the SMD under high temperature.
- Do not scratch or wipe the lens since the lens and gold wire inside are rather fragile and cross out easy to break.
- LED should be used as soon as possible when being taken out of the original package, and should be stored in anti-moisture and anti-ESD package.
- This usage and handling instructions are for reference only.

Tape and reel specifications

Tape dimensions (unit: mm)

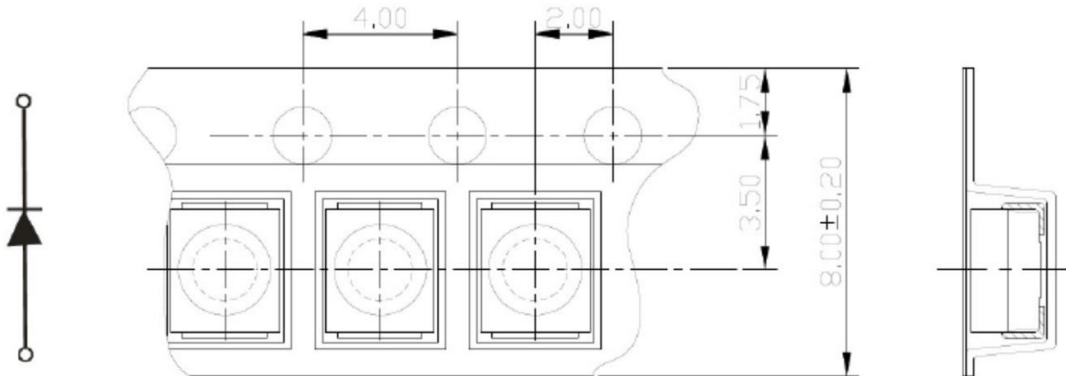

Tape layout

Not drawn to scale.

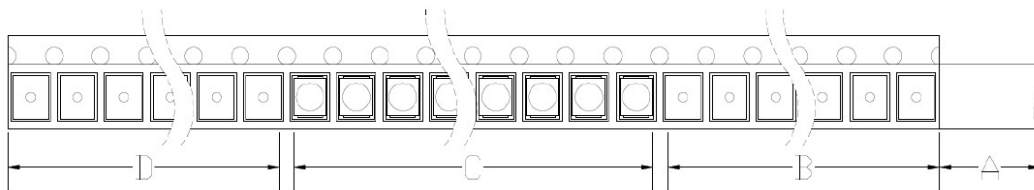

- A: Cover tape, 300mm;
- B: Empty leader, 200mm;
- C: LED, 4000pcs;
- D: Empty trailer, 200mm.

Tape and reel specifications

Reel dimensions top (unit: mm)

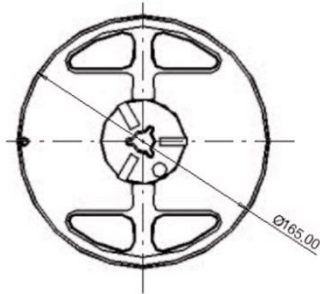

Reel dimensions bottom (unit: mm)

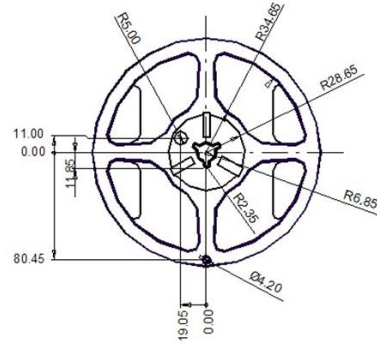

Reel dimensions side (unit: mm)

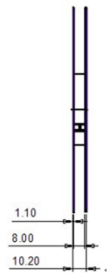

Feeding direction

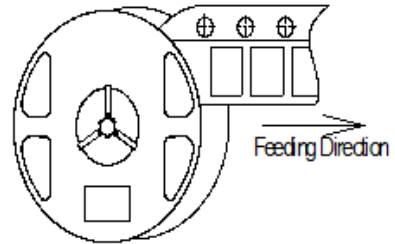

Box packaging

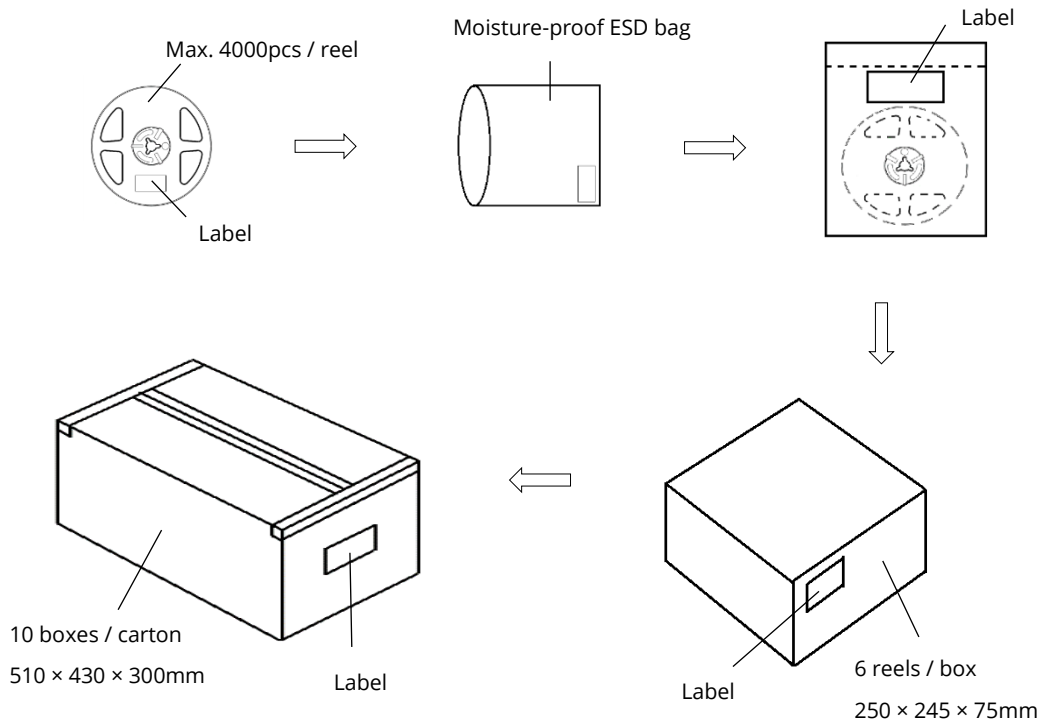

- Reeled products (max 4000pcs / reel) are packed in a moisture-proof bag along with a moisture desiccant pack.
- Each inner box contains up to 6 moisture-proof bag (total maximum number of SMDs is 24000pcs). Box package size: 250 mm × 245 mm × 75 mm.
- Each outer package contains 10 inner boxes. Box size: 510 mm × 430 mm × 300 mm.
- Outer package is sealed with protective bubble wrap and foam. (Part numbers, lot numbers, quantity should appear on the label on the moisture-proof bag, part numbers).
- This packaging merely intended as a reference for standard quantity orders only – please note that actual packaging can differ depending on the order circumstances.

About Yujileds



The Yuji story

Yuji started with LED phosphor materials in 2006, and today we are known for nitride red LED phosphor with superior brightness and stability in the world. With the rapid growth in LED industry during the past years, we have serviced over 260 business customers in over 33 different countries or regions, and established subsidiaries or distributors in 6 locations including China, US, UK and Japan, now we are reaching the global markets with the full coverage efficiently.

Our capabilities and achievements

In Yujileds®, we are a group of people passionate in creating the maximum value for customers. Dedicated to developing LED phosphor, LED light source and final products, we have accumulated unique experience in different projects. Nowadays, over 30 experts are gathered in a variety of areas including but not limited to semiconductor, chemistry, optics, photoelectricity, circuitry, materials and color science.

In commercial markets, we have been dedicating to providing comprehensive solutions for specific applications by deeply understanding these markets. Our goal is not only to offer an LED product simply but is to grow with customers and share the success of a business.

Main website: www.yujiintl.com

Find the comprehensive introduction of Yuji company and our insights into a variety of advanced technologies and applications.

Contact: info@yujigroup.com

Subordinative website: www.yujileds.com

Find more about our products, technical posts, featured support and service, blogs, news and whatever interesting and practical information.

Contact: contact@yujileds.com

Online shop: store.yujiintl.com

Find your favorite Yujileds® products with outstanding quality, fast shipment and superb sale service.

Contact: webstore@yujigroup.com